

SCHEDA PRODOTTO

Fianchi / basamenti / cappelli / ripiani / divisori:

Pannello in particelle di legno E1 spessore mm 25/38 rivestito con fogli impregnati di resina melamminica effetto tessuto oppure effetto legno. Cappelli e basamenti nella versione ad ante battenti dotati di profilo frontale parapolvere in estruso.

Bordi per fianchi / basamenti / cappelli / ripiani / divisori:

In pvc sp.mm.1 con rivestimento effetto tessuto oppure effetto legno.

Altri bordi:

In tranciato di vero legno sp. mm 0,6 in tanganika, essenze a campionario oppure in resina poliestere sp. mm 0,6 laccato o in pvc sp. mm 0,6 con rivestimento effetto tessuto oppure effetto legno.

Schienali:

Pannello in particelle di legno E1 spessore mm 10 rivestito con fogli impregnati di resina melamminica effetto tessuto oppure effetto legno.

Ripiani e divisori in vero legno:

Pannello in particelle di legno extralight E1 spessore mm 25/40 impiallacciato con tranciato di vero legno nelle varie essenze di campionario.

Ante Battenti modello Piana / Orizzonte / Inserto / Segno / Groove

Pannello in particelle di legno extralight E1 spessore mm.25 impiallacciato con tranciato di vero legno nelle varie essenze di campionario oppure rivestito di resina poliestere e laccato. Ogni anta è dotata di 6 cerniere.

Anta Battente modello Trattino / Tratto / Dream / Up and Down

Pannello in particelle di legno extralight E1 spessore mm 25 impiallacciato con tranciato di vero legno nelle varie essenze di campionario oppure rivestito di resina poliestere e laccato. Ogni anta è dotata di 6 cerniere e di un profilo maniglia in alluminio laccato applicato sul filo dell'anta.

Anta battente modello Linear

Anta con telaio perimetrale spessore mm 35 in alluminio laccato opaco antracite - vetro spessore mm 4 temperato.

Ogni anta è dotata di cerniere invisibili con ralentatore integrato.

Anta Scorrevole modello Piana / Segno

Pannello in particelle di legno extralight E1 spessore mm 25 impiallacciato con tranciato di vero legno nelle varie essenze di campionario oppure rivestito di resina poliestere e laccato. Tenditori raddrizza ante incassati a filo nella parte posteriore in metallo, profili para-polvere a spazzolino longitudinali. Apertura con maniglia.

Anta Scorrevole modello Profilo Verticale / Profilo Orizzonte

Pannello in particelle di legno extralight E1 spessore mm 25 impiallacciato con tranciato di vero legno nelle varie essenze di campionario oppure rivestito di resina poliestere e laccato. Profilo maniglia in alluminio laccato o impiallacciato nelle essenze a campionario con inserto tenditore raddrizza ante e profili para-polvere a spazzolino longitudinali.

Anta Scorrevole modello Strip / Sheald 3 / Sheald 4

Pannello in particelle di legno extralight E1 spessore mm 25 impiallacciato con tranciato di vero legno nelle varie essenze di campionario oppure rivestito di resina poliestere e laccato. Profilo maniglia in alluminio laccato o impiallacciato nelle essenze a campionario con inserto tenditore raddrizza ante e profili para-polvere a spazzolino longitudinali.

Ante Scorrevoli modello Emotion / Emotion Basic

Pannello in particelle di legno extralight E1 spessore mm 25 impiallacciato con tranciato di vero legno nelle varie essenze di campionario oppure rivestito di resina poliestere e laccato. Per Emotion Basic: pannello a particelle di legno E1 spessore mm 25 rivestito con fogli impregnati di resina melamminica effetto legno laccato a poro aperto. Profilo maniglia in alluminio laccato o impiallacciato nelle essenze a campionario con inserto tenditore raddrizza ante e profili para-polvere a spazzolino longitudinali.

Fasce decorative in vetro retro-laccato sp. mm 4 oppure in legno compensato sp. mm 4 impiallacciato nelle essenze a campionario inserite a filo anta mediante incollaggio silconico.

Anta Scorrevole modello Max 4

Pannello in tamburato rivestito con pannello a particelle di legno extralight E1 spessore mm 40 impiallacciato con tranciato di vero legno nelle varie essenze di campionario oppure rivestito di resina poliestere e laccato. Tenditori raddrizza ante incassati a filo nella parte posteriore in metallo, profili para-polvere a spazzolino longitudinali.

Cassettiere interne:

Box perimetrale a 3 lati in pannello a particelle di legno E1 rivestito in pvc effetto tessuto. Fondo ricavato da pannello a particelle di legno E1 rivestito in pvc effetto tessuto.

Top e fianchi: pannello in particelle di legno E1 spessore mm 38 rivestito con fogli impregnati di resina melamminica effetto tessuto.

FERRAMENTA:

- Cerniere per ante:

marca Salice in acciaio nichelato regolabili tridimensionalmente a libero movimento / con molla di richiamo / con ralentatore.

- Guide cassetto:

marca Blum invisibili con scorrimento a sfera ad estrazione parziale o totale in acciaio zincato e nylon.

- Montaggi dei contenitori:

in metallo con incasso a filo

- Reggi ripiani:

in metallo e nylon con incasso a filo

- Piedini livellatori regolabili:

in acciaio zincato e nylon

- Viteria in acciaio:

nichelata/zincata

- Meccanismi porta tv brevettati:

in acciaio/alluminio e nylon caricato vetro verniciati epox nero testurizzato con guide di scorrimento a sfera ad alta portata in acciaio zincato.

- Tubi appendiabito:

in alluminio con supporti in zama verniciato a polveri epox.

- Tubi appendiabito saliscendi:

in acciaio cromato e nylon.

- Tiretto appendiabiti / Porta abiti estraibile / Porta cravatte / Porta cinture / porta scarpe:

in acciaio nichelato/verniciato o alluminio e materiale plastico.

- Porta pantaloni estraibile a vassoio:

in alluminio anodizzato montato su guide a sfera di scorrimento.

- Porta cinture estraibile a vassoio:

in alluminio anodizzato con piano in vetro satinato montato su guide a sfera di scorrimento.

- Traverse elementi ponte:

in acciaio verniciato a polveri epox

- Ante scorrevoli:

con meccanismo a scorrimento superiore a sfere con fermo di guida inferiore e fermi superiori dotati di ammortizzatore in metallo e nylon. Binari di scorrimento in alluminio anodizzato.

- Ante pieghevoli spogliatoio:

con meccanismo a scorrimento superiore a sfere con fermo di guida in nylon. Binario di scorrimento in alluminio anodizzato.

FINITURE:

Essenze vero legno di:

Olmo / Olmo Piombo / Olmo Rame / Olmo Ruggine / Olmo zinco / Olmo Lava / Olmo Titanio Metallizzato / Rovere Grigio / Olmo Acquerello / Quercia 25-50-75-100 - levigati dal legno grezzo naturale e spazzolati/rusticati con spazzole in acciaio e tynex - applicazione di tinte a straccio effetto poro marcato vivo - fondo e finitura acrilico opaco poro aperto. Eucalipto / Palissandro Santos / Noce Canaletto / Noce Random impiallacciatura levigata dal legno grezzo - fondo e finitura acrilico opaco poro aperto.

Laccato Opaco:

Verniciatura opaca poliuretana a poro chiuso in quattro mani su fondo poliestere levigato.

Laccato Lucido:

Verniciatura base poliestere con finitura superficiale poliuretana pigmentata a poro chiuso brillantata.

Laccato Poro aperto:

Verniciatura opaca poliuretana a poro aperto in quattro mani su fondo acrilico levigato su essenza di vero legno Rovere spazzolato.

Essenza 1

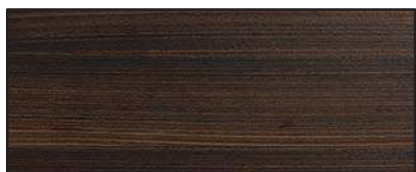

EUCALIPTO

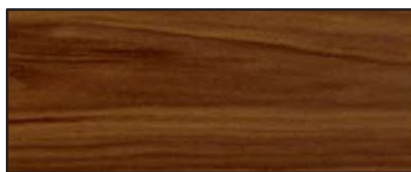

PALISSANDRO SANTOS

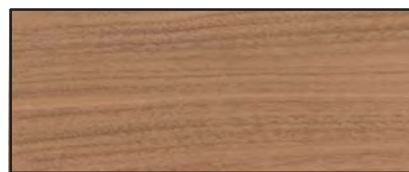

NOCE CANALETTO

Essenza 2

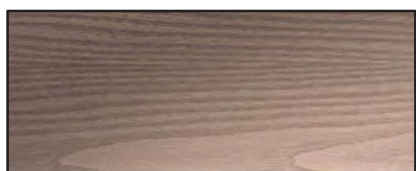

OLMO

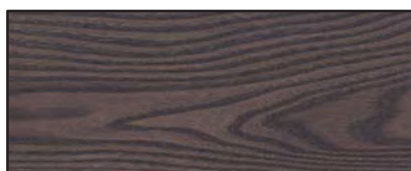

OLMO PIOMBO



OLMO RAME

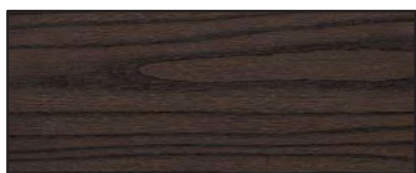

OLMO RUGGINE



OLMO ZINCO

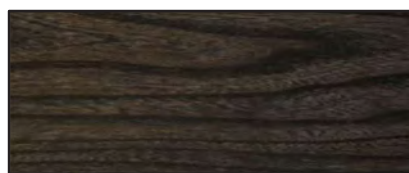

OLMO LAVA



OLMO TITANIO

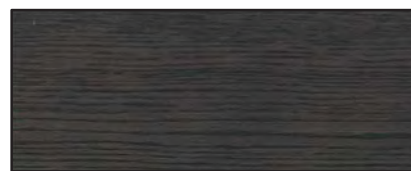

ROVERE GRIGIO

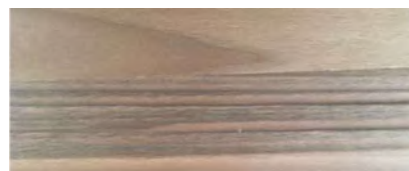

NOCE RANDOM



QUERCIA 25 S



QUERCIA 50 C

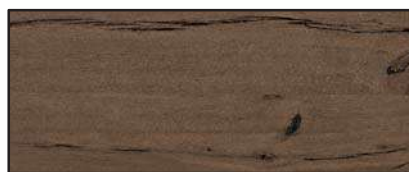

QUERCIA 75 G



QUERCIA 100 N

Le tonalità dei colori qui riportati hanno valore puramente indicativo

OLMO ACQUERELLO

Essenza 2



INVERNO



PIETRA



OCRA



AVIO



KAKI

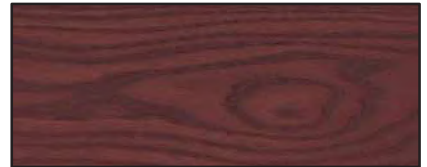

MATTONE



PRUGNA

MELAMINICO

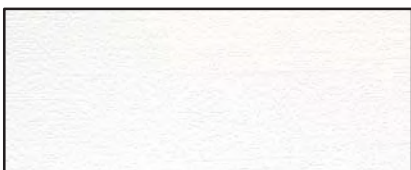

BIANCO TEXTURA



GRIGIO TEXTURA



OLMO PERLA



OLMO BROWN

Le tonalità dei colori qui riportati hanno valore puramente indicativo

LACCATURE

- LACCATO OPACO
- LACCATO PORO APERTO (prezzo Essenza 2)
- LACCATO LUCIDO (vedi pag. finiture personalizzate)



INVERNO

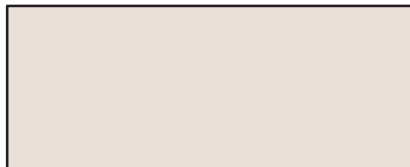

LATTE



GIGLIO

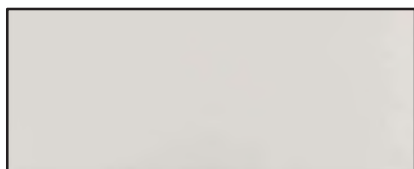

GRANIT

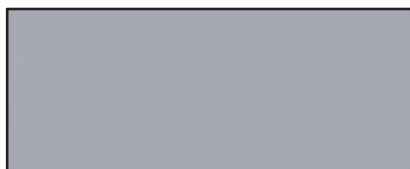

PIETRA



FUMO



BASALTO



POMICE

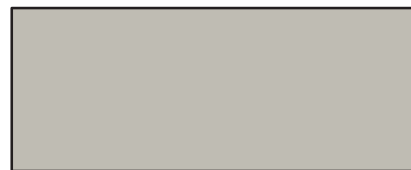

POLVERE

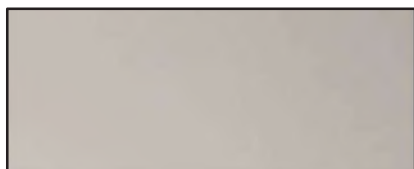

SABBIA

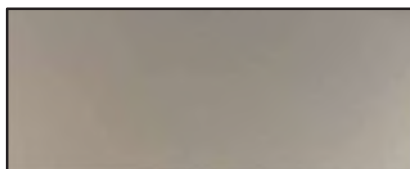

VISONE

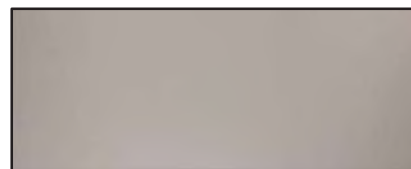

FERRO



ARGILLA



CEMENTO



QUARZO



ANTRACITE



TORTORA



ARDESIA

Le tonalità dei colori qui riportati hanno valore puramente indicativo

LACCATURE

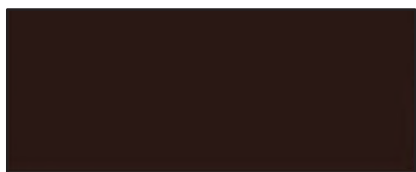

MOKA

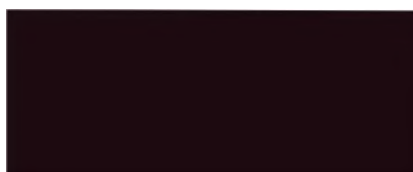

CAFFÉ



NERO



CORDA

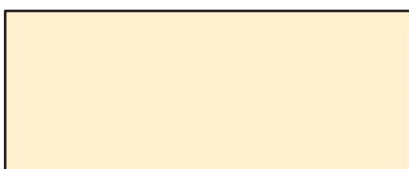

PANNA



MANGO



SENAPE



MANDARINO



ARANCIO SOFT



OCRA



OSSIDO



ROSSO



MATTONE



PRUGNA



TUNDRA



PRIMAVERA



OLIVA



KAKI



FIORDALISO



AVIO

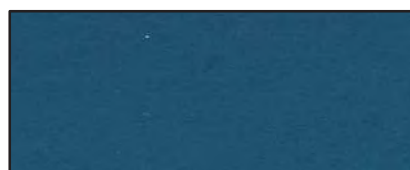

BLU

Le tonalità dei colori qui riportati hanno valore puramente indicativo

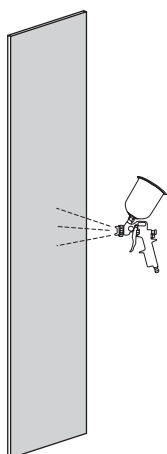

LACCATURA OPACA o PORO APERTO scala RAL, NCS, a CAMPIONE

Fino ad un valore di € 500 di listino
Da un valore di € 500 a € 2.500 di listino
Oltre valore di € 2.500 di listino

Codice **MLAC1G +** €
Codice **MLAC2G +** €
Codice **MLAC3G +** €

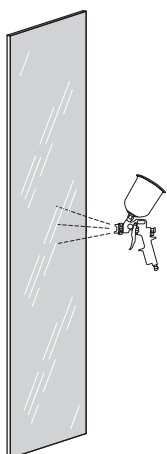

LACCATURA LUCIDA fondo poliestere brillantata (spazzolato 4 mani)

Prezzo riferito al Metro quadrato calcolato su ogni faccia

Codice **MLL +** €

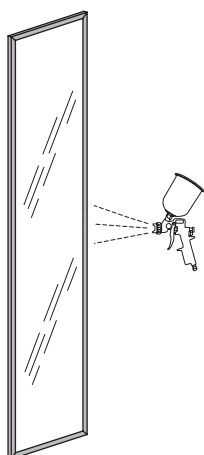

LACCATURA OPACO su telai ante in alluminio LINEAR

Maggiorazione FISSA riferita ad ogni telaio indipendentemente dalla dimensione

Codice **LAL +** €

ARMADI ANTA BATTENTE - Sezione

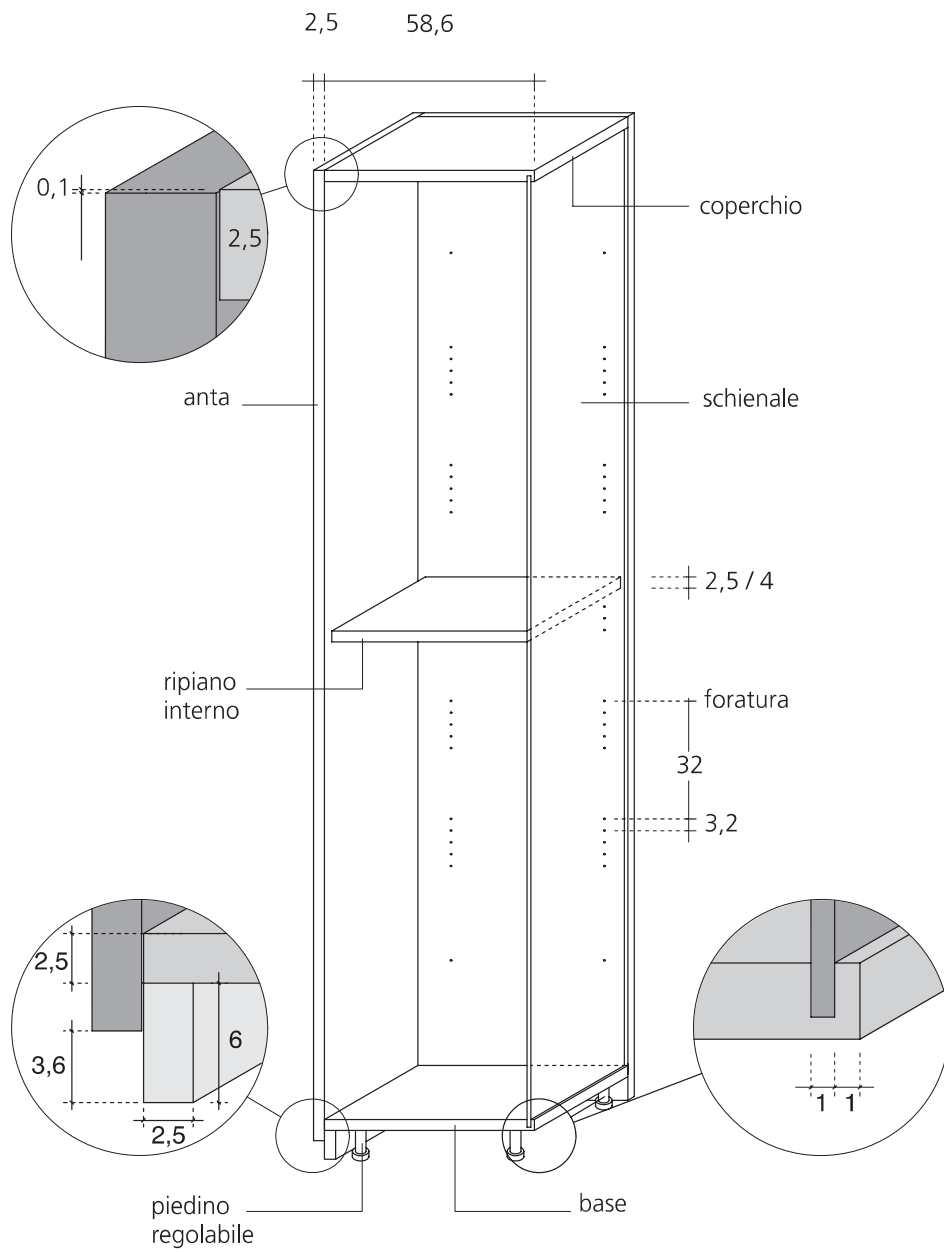

ARMADI ANTA BATTENTE - Modularita'

DIMENSIONI

4 altezze

cm 230,8
cm 246,8
cm 261,6
cm 294,8

8 larghezze (basamento + 1 fianco)

cm 32
cm 48
cm 56
cm 64
cm 80
cm 96
cm 112
cm 128

Profondità

Fianco cm 58,6
Totale con anta cm 61,3

A richiesta senza sovrapprezzo:

Fianco P cm 42,6 (misura Tot con anta P. cm 45,3)

FIANCHI

Spessore mm. 25

Foratura passo 32 cm a grappoli di fori

FIANCHI INTERNI

Finiture: melaminico bianco textura
melaminico grigio textura
melaminico olmo perla
melaminico olmo brown

FIANCHI ESTERNI

Hanno l'interno nelle finiture melaminico e l'esterno personalizzabile nelle essenze o laccature nostro campionario.

COPERCHI E BASI

Spessore mm. 25

Guarnizione parapolvere per la battuta delle ante

Finiture: melaminico bianco textura
melaminico grigio textura
melaminico olmo perla
melaminico olmo brown

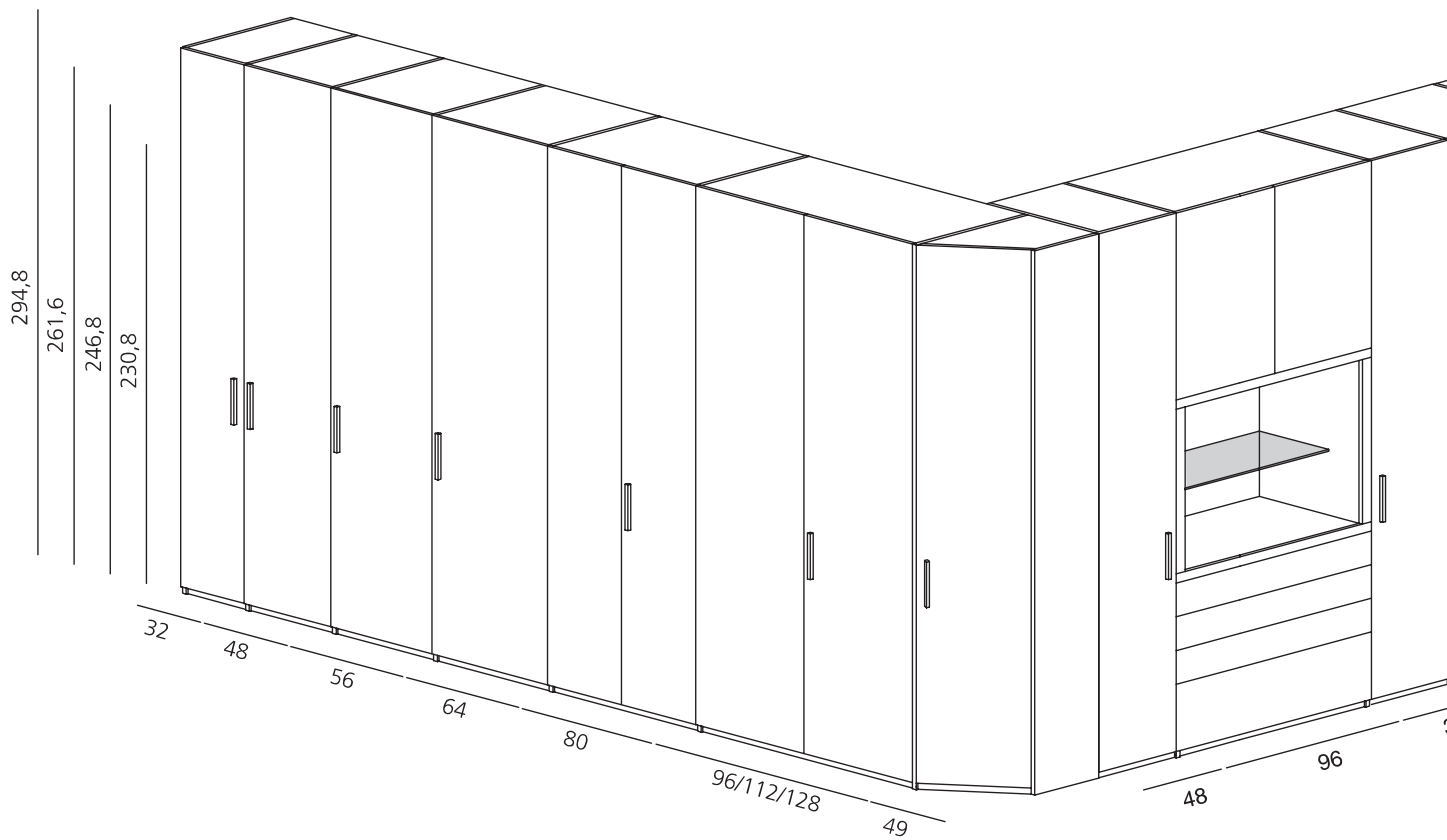

RIPIANI

Spessore mm. 25
Spessore mm. 40

Finiture: melaminico bianco textura
melaminico grigio textura
melaminico olmo perla
melaminico olmo brown
essenze campionario
(solo per spessore mm 40)

SCHIENALI

Spessore mm. 10

Finiture: melaminico bianco textura
melaminico grigio textura
melaminico olmo perla
melaminico olmo brown

TOLLERANZE PER IL MONTAGGIO

in ALTEZZA:
1 cm in più dell'altezza dell'armadio

in LARGHEZZA:
5 cm in più della larghezza dell'armadio

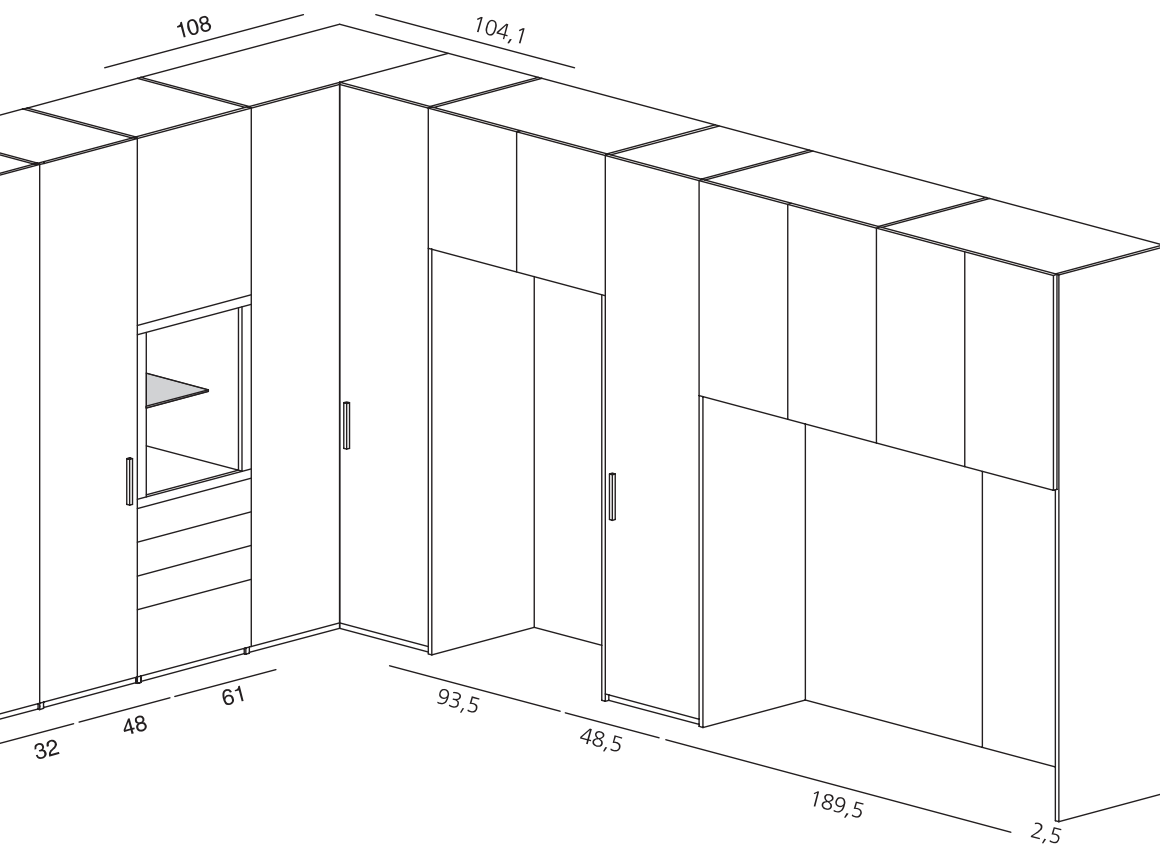

POSSIBILITÀ DI UTILIZZO

Armadio in nicchia

Su richiesta è possibile predisporre l'armadio con ferramenta per il montaggio in nicchia: spazio minimo per il montaggio

ALTEZZA cm 2 - LARGHEZZA cm 1

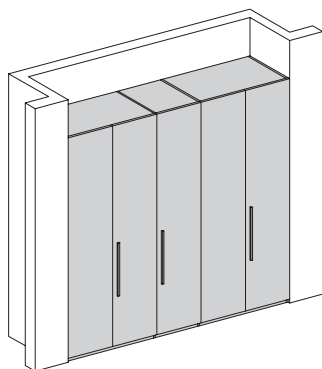

Armadio in nicchia con chiusure laterali e orizzontali

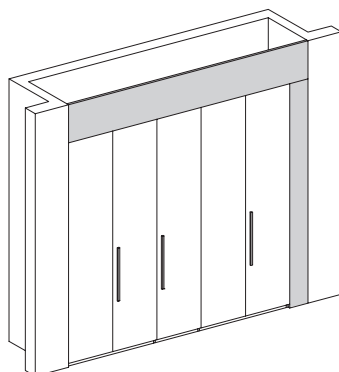

Armadio con elemento terminale

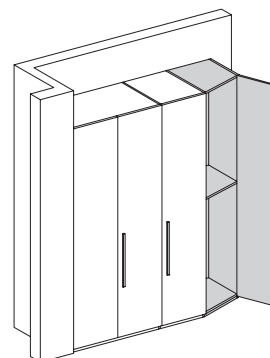

Soluzione ad angolo

Utilizzo di ante con cerniere 180°

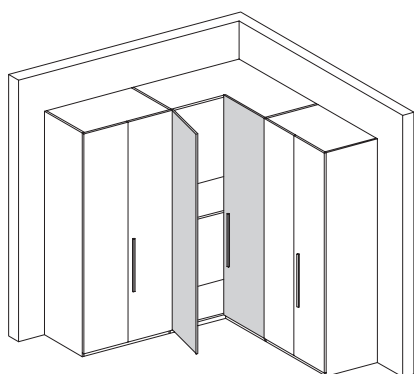

Cambio di profondità per presenza di pilastro

Aggiungere al prezzo dell'armadio le eventuali riduzioni in profondità modulo

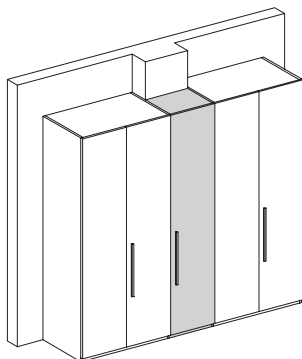

Cambio di profondità

Aggiungere al prezzo dell'armadio le eventuali riduzioni in profondità modulo

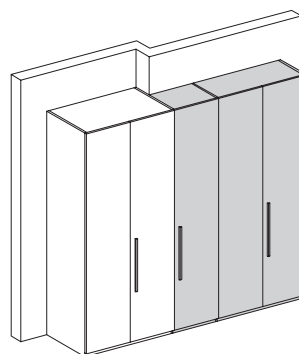

Ponti

Larghezze
cm. 93,5 - 109,5 - 125,5 - 141,5 - 157,5 -
165,5 - 189,5 - 221,5 - 253,5

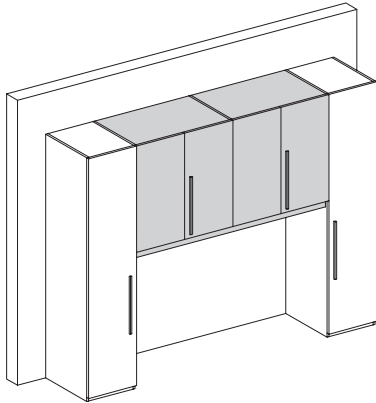

Armadio con spogliatoio

Soluzioni a 2 ante, a 3 ante.

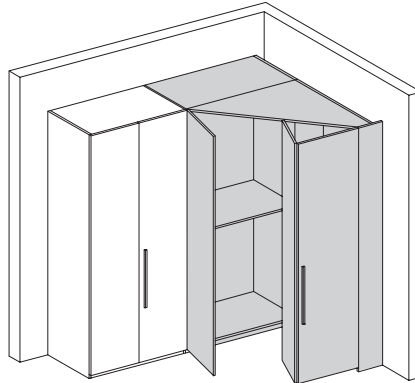

Soluzione a scaletta per mansarde

Aggiungere al prezzo dell'armadio
le eventuali riduzioni in altezza dei
moduli e la maggiorazione per taglio
inclinato delle ante.
Contattare il Nostro Ufficio Tecnico
per la fattibilità.

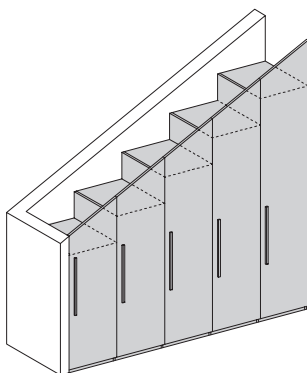

Soluzione a scaletta per mansarde

Aggiungere al prezzo dell'armadio
le eventuali riduzioni in altezza
dei moduli

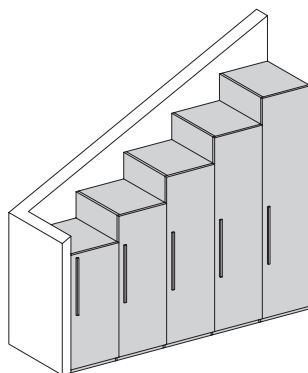

MODULI ARMADIO SENZA ANTE - profondità cm. 58,6

STRUTTURA MODULI ARMADIO P. cm 58,6 (P. cm 42,6 stesso prezzo)

melaminico bianco texture
melaminico grigio texture
melaminico olmo perla
melaminico olmo brown

Compreso 1 fianco struttura
Compreso 1 ripiano interno

H. (in cm)	L. cm 32		L. cm 48		L. cm 56		L. cm 64	
	Codice	Prezzo	Codice	Prezzo	Codice	Prezzo	Codice	Prezzo
230,8	S231		S232		S233L		S233	
246,8	S241		S242		S243L		S243	
261,6	S261		S262		S263L		S263	
294,8	S291		S292		S293L		S293	

STRUTTURA MODULI ARMADIO P. cm 58,6 (P. cm 42,6 stesso prezzo)

melaminico bianco texture
melaminico grigio texture
melaminico olmo perla
melaminico olmo brown

Compreso 1 fianco struttura
Compreso 1 ripiano interno

H. (in cm.)	L. cm 108 x 104,1		Fianco struttura	
	Codice	Prezzo	Codice	Prezzo
230,8	S237		S31	
246,8	S247		S46	
261,6	S267		S62	
294,8	S297		S95	

L. cm 80

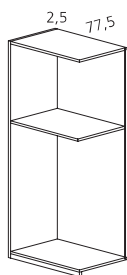

L. cm 96

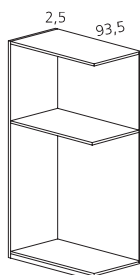

L. cm 112

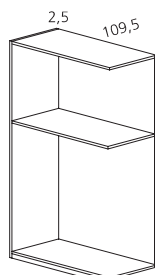

L. cm 128

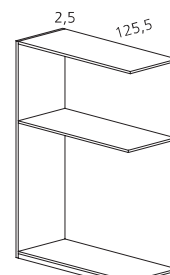

Fianco struttura

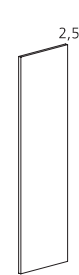

Codice	Prezzo	Codice	Prezzo	Codice	Prezzo	Codice	Prezzo	Codice	Prezzo
S234	355	S235		S236L		S236		S31	
S244	355	S245		S246L		S246		S46	
S264	355	S265		S266L		S266		S62	
S294	410	S295		S296L		S296		S95	

L. cm 51,5 Dx - Sx

Compreso 1 fianco struttura
Compreso 1 fianco esterno
Compreso 1 ripiano interno

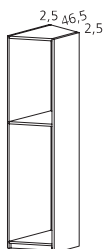

H. (in cm.)	Codice	Prezzo
230,8	S238	
246,8	S248	
261,6	S268	
294,8	S298	

ANTA PIANA

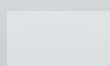



Maniglia in legno sagomata
finiture a campionario
Codice TA104 € 40
H. totale da terra cm 118,6



Maniglia in legno sagomata
finiture a campionario
Codice TA18 € 10
H. da terra cm 116,4

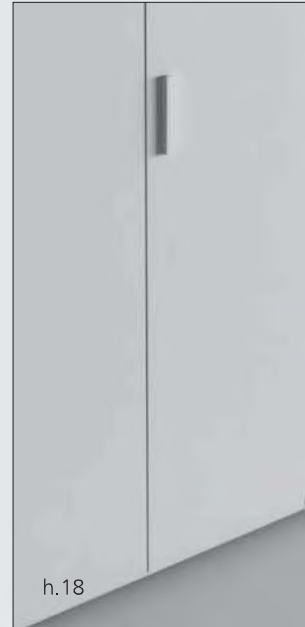

Maniglia in metallo
finitura grigio alluminio
Codice LAP € 60
H. totale da terra cm 105,6



Maniglia in metallo
finitura grigio alluminio
Codice MN12 € 10
H. totale da terra cm 114,4



Anta battente PIANA - Caratteristiche, modularità e finiture



Anta Battente PIANA

Anta spessore mm 25 in agglomerato superleggero con 6 cerniere per anta con apertura a 110° con chiusura rallentata. Nei moduli a due ante è applicato un profilo parapolvere sull'anta di sinistra. Coperchio e base con profilo parapolvere.

Finiture previste anta PIANA

Essenze nostro campionario impiallacciato verticale
Laccato opaco
Laccato lucido spazzolato

Maniglia

Vedi pag. 229

LARGHEZZA

- Moduli con struttura P. cm 58,6
- Moduli con struttura P. cm 42,6

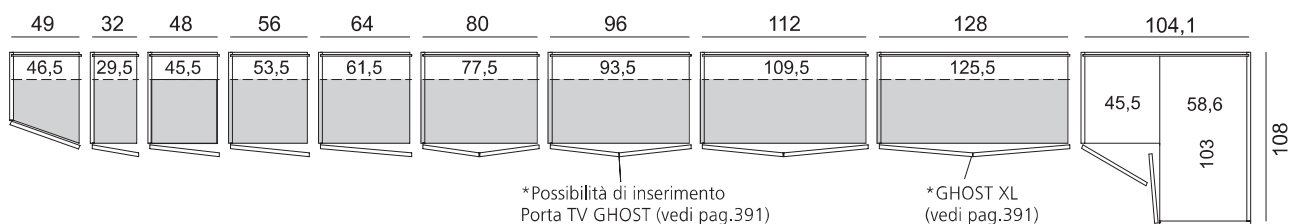

ALTEZZA

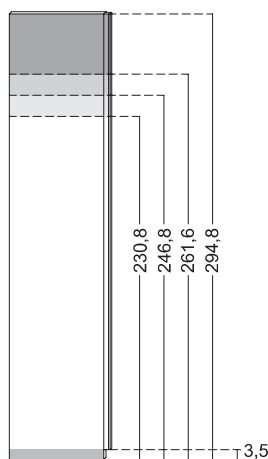

PROFONDITÀ

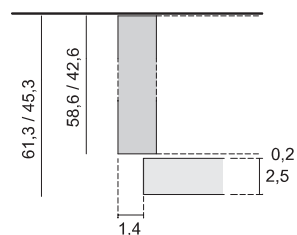

Riduzioni struttura

RIDUZIONE in LARGHEZZA

Il prezzo della riduzione è comprensivo dei tagli:

- Coperchio
- Base
- 1 ripiano
- Schienale

- Anta

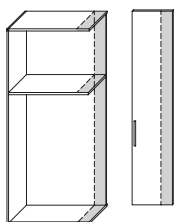

RIDUZIONE in PROFONDITÀ

Il prezzo della riduzione è comprensivo dei tagli e foratura supplementare:

- Coperchio
- Base
- 1 ripiano
- 1 fianco

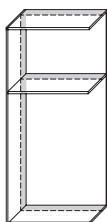

RIDUZIONE in ALTEZZA

Il prezzo della riduzione è comprensivo dei tagli:

- Fianco
- Schienale

- Anta

- Anta con taglio inclinato

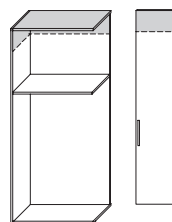

Anta battente PIANA - Composizioni

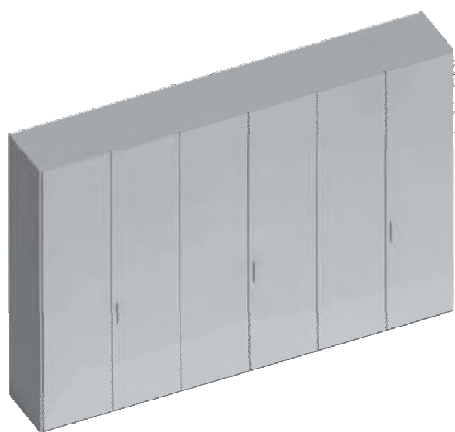

- Armadi P. cm 45,3 stesso prezzo
- Prezzi comprensivi di finitura fianchi come anta
- Escluse maniglie vedi pag. 229
- Incluso un ripiano strutturale Sp. cm 4 a modulo
- Possibilità di inserimento **PORTA TV GHOST** vedi pag.391

3 ANTE

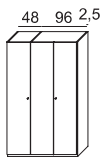
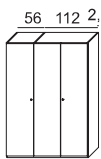
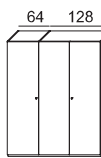
	H.	Codice	Essenza 1	Essenza 2	Laccato Opaco
 L. cm 146,5	230,8	CB3A01			
	246,8	CB4A01			
	261,6	CB6A01			
	294,8	CB9A01			
 L. cm 170,5	230,8	CB3B01			
	246,8	CB4B01			
	261,6	CB6B01			
	294,8	CB9B01			
 L. cm 194,5	230,8	CB3C01			
	246,8	CB4C01			
	261,6	CB6C01			
	294,8	CB9C01			

5 ANTE

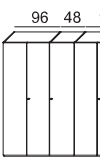
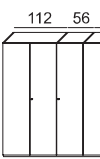
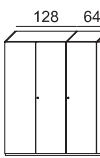
	H.	Codice	Essenza 1	Essenza 2	Laccato Opaco
 L. cm 242,5	230,8	CB3G01			
	246,8	CB4G01			
	261,6	CB6G01			
	294,8	CB9G01			
 L. cm 282,5	230,8	CB3H01			
	246,8	CB4H01			
	261,6	CB6H01			
	294,8	CB9H01			
 L. cm 322,5	230,8	CB3L01			
	246,8	CB4L01			
	261,6	CB6L01			
	294,8	CB9L01			

4 ANTE

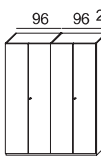
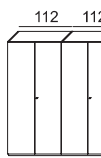
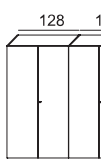
 L. cm 194,5	230,8	CB3D01			
	246,8	CB4D01			
	261,6	CB6D01			
	294,8	CB9D01			
 L. cm 226,5	230,8	CB3E01			
	246,8	CB4E01			
	261,6	CB6E01			
	294,8	CB9E01			
 L. cm 258,5	230,8	CB3F01			
	246,8	CB4F01			
	261,6	CB6F01			
	294,8	CB9F01			

6 ANTE

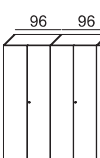
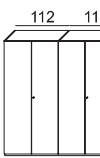
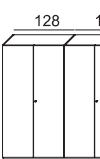
 L. cm 290,5	230,8	CB3M01			
	246,8	CB4M01			
	261,6	CB6M01			
	294,8	CB9M01			
 L. cm 338,5	230,8	CB3N01			
	246,8	CB4N01			
	261,6	CB6N01			
	294,8	CB9N01			
 L. cm 386,5	230,8	CB3P01			
	246,8	CB4P01			
	261,6	CB6P01			
	294,8	CB9P01			

Moduli armadio battente ANTA PIANA

Il prezzo del modulo

comprende:

- 1 fianco struttura Sp. cm 2,5
- 1 ripiano interno Sp. cm 4

Escluse maniglie

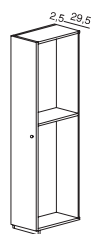

L. cm 32

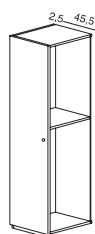

L. cm 48

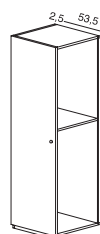

L. cm 56

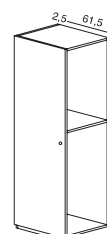

L. cm 64

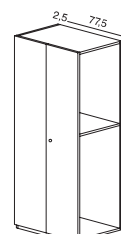

L. cm 80

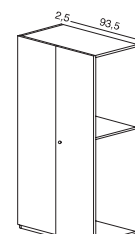

L. cm 96

H. 230,8

Codice

B3301

B3401

B3501

B3601

B3801

B3901

Essenza 1

Essenza 2

Laccato opaco

Laccato lucido

H. 246,8

B4301

B4401

B4501

B4601

B4801

B4901

Essenza 1

Essenza 2

Laccato opaco

Laccato lucido

H. 261,6

B6301

B6401

B6501

B6601

B6801

B6901

Essenza 1

Essenza 2

Laccato opaco

Laccato lucido

H. 294,8

B9301

B9401

B9501

B9601

B9801

B9901

Essenza 1

Essenza 2

Laccato opaco

Laccato lucido

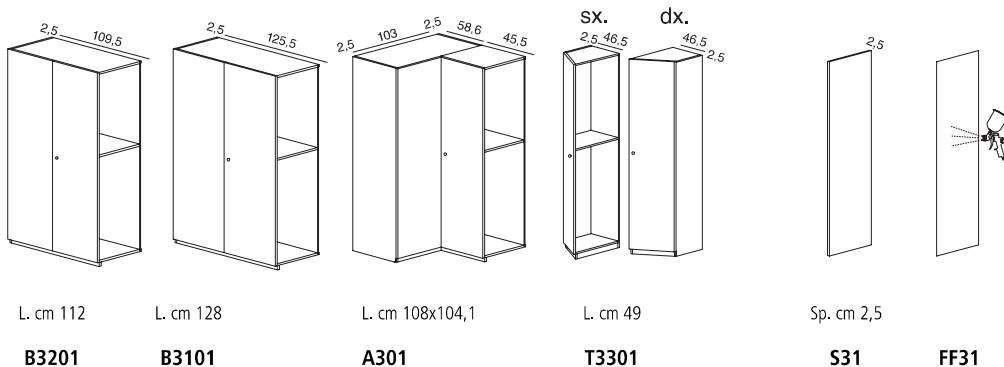

CASSETTIERE interne 4 cassetti con guide ammortizzate

Per estrazione totale aggiungere per cassetto +



- L. cm 45,5
- L. cm 53,5
- L. cm 61,5
- L. cm 77,5
- L. cm 93,5
- L. cm 109,5
- L. cm 125,5

B4201 B4101 A401 T4301 S46 FF46

Ripiani interni



Sp. 2,5 | Sp. 4

- L. 29,5
- L. 45,5
- L. 53,5
- L. 61,5
- L. 77,5
- L. 93,5
- L. 109,5
- L. 125,5
- Per angolare
- Per terminale

B6201 B6101 A601 T6301 S62 FF62

Tubi appendiabiti alluminio

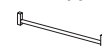

B9201 B9101 A901 T9301 S95 FF95

- L. 29,5
- L. 45,5
- L. 53,5
- L. 61,5
- L. 77,5
- L. 93,5
- L. 109,5
- L. 125,5
- Per angolare

ANTA ORIZZONTE

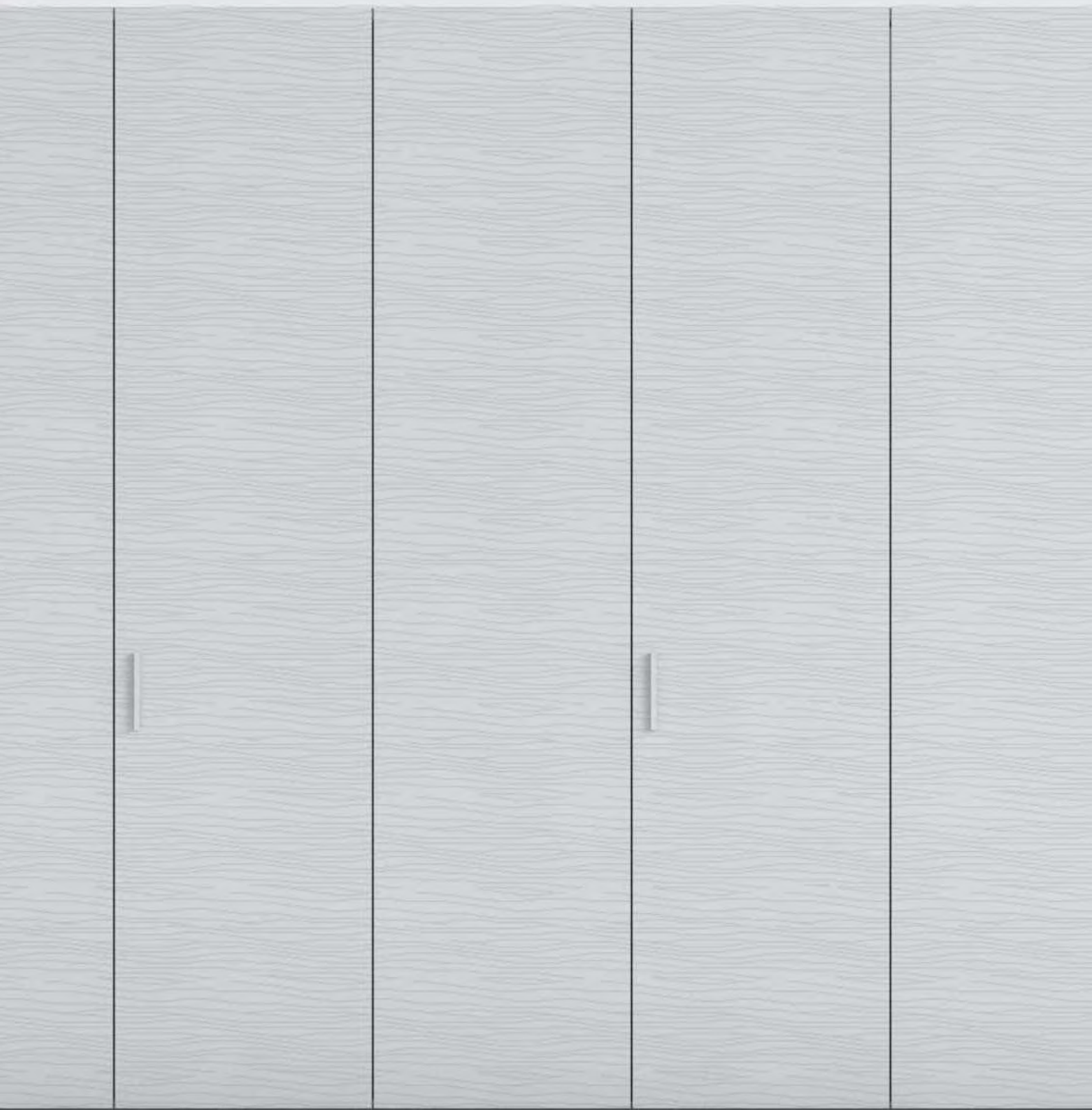



Maniglia in legno sagomata
finiture a campionario
Codice TA104 € 40
H. totale da terra cm 118,6



Maniglia in legno sagomata
finiture a campionario
Codice TA18 € 10
H. da terra cm 116,4

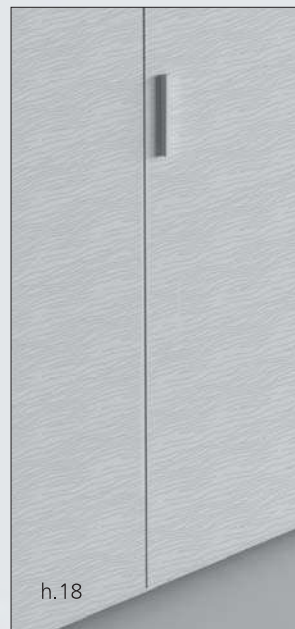

Maniglia in metallo
finitura grigio alluminio
Codice LAP € 60
H. totale da terra cm 105,6

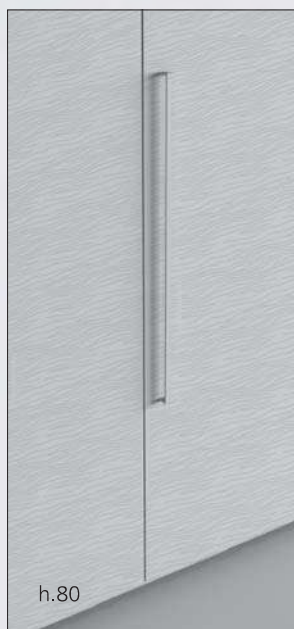

Maniglia in metallo
finitura grigio alluminio
Codice MN12 € 10
H. totale da terra cm 114,4

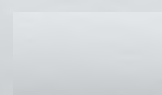
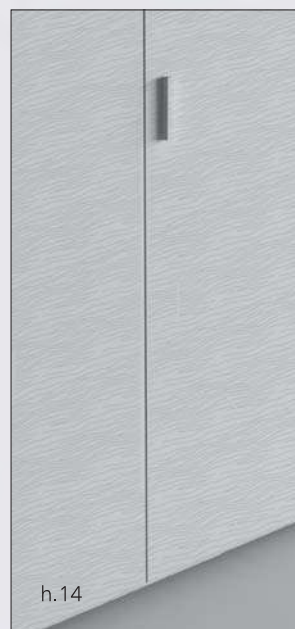

Anta battente ORIZZONTE - Caratteristiche, modularità e finiture



Anta Battente ORIZZONTE

Anta spessore mm 25 in agglomerato superleggero con 6 cerniere per anta con apertura a 110° con chiusura rallentata. Nei moduli a due ante è applicato un profilo parapolvere sull'anta di sinistra. Coperchio e base con profilo parapolvere.

Finiture previste anta ORIZZONTE - Essenze nostro campionario impiallacciato orizzontale

Maniglia

Vedi pag. 235

LARGHEZZA

- Moduli con struttura P. cm 58,6
- Moduli con struttura P. cm 42,6

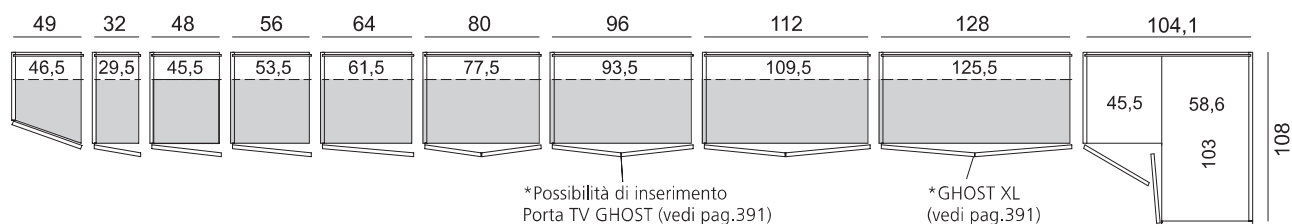

ALTEZZA

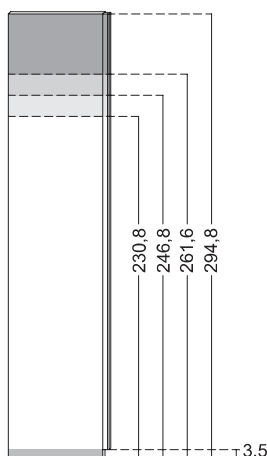

PROFONDITÀ

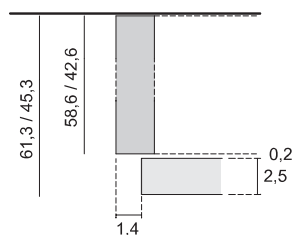

Riduzioni struttura

RIDUZIONE in LARGHEZZA Euro
Il prezzo della riduzione è comprensivo dei tagli:

- Coperchio	Euro
- Base	Euro
- 1 ripiano	Euro
- Schienale	Euro
- Anta	Euro

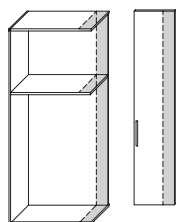

RIDUZIONE in PROFONDITÀ Euro
Il prezzo della riduzione è comprensivo dei tagli e foratura supplementare:

- Coperchio	Euro
- Base	Euro
- 1 ripiano	Euro
- 1 fianco	Euro

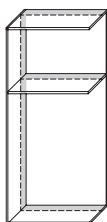

RIDUZIONE in ALTEZZA Euro
Il prezzo della riduzione è comprensivo dei tagli:

- Fianco	Euro
- Schienale	Euro
- Anta	Euro
- Anta con taglio inclinato	Euro

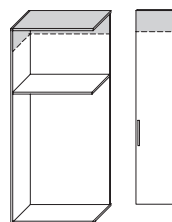

Anta battente ORIZZONTE - Composizioni

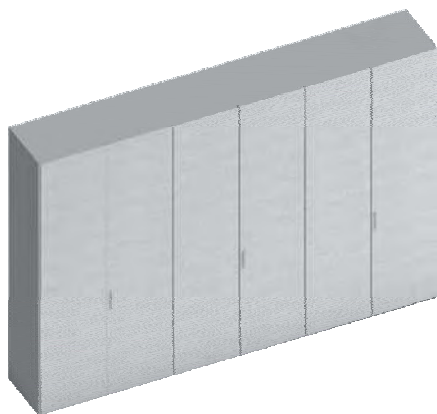

- Armadi P. cm 45,3 stesso prezzo
- Prezzi comprensivi di finitura fianchi come anta
- Escluse maniglie vedi pag. 235
- Incluso un ripiano strutturale Sp. cm 4 a modulo
- Possibilità di inserimento **PORTA TV GHOST** vedi pag. 391

3 ANTE

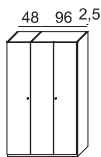
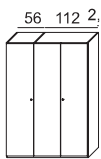
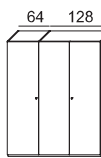
	H.	Codice	Essenza 1	Essenza 2
 L. cm 146,5	230,8	CB3A02		
	246,8	CB4A02		
	261,6	CB6A02		
	294,8	CB9A02		
 L. cm 170,5	230,8	CB3B02		
	246,8	CB4B02		
	261,6	CB6B02		
	294,8	CB9B02		
 L. cm 194,5	230,8	CB3C02		
	246,8	CB4C02		
	261,6	CB6C02		
	294,8	CB9C02		

5 ANTE

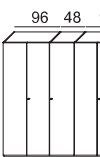
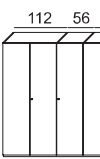
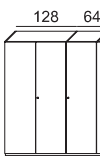
	H.	Codice	Essenza 1	Essenza 2
 L. cm 242,5	230,8	CB3G02		
	246,8	CB4G02		
	261,6	CB6G02		
	294,8	CB9G02		
 L. cm 282,5	230,8	CB3H02		
	246,8	CB4H02		
	261,6	CB6H02		
	294,8	CB9H02		
 L. cm 322,5	230,8	CB3L02		
	246,8	CB4L02		
	261,6	CB6L02		
	294,8	CB9L02		

4 ANTE

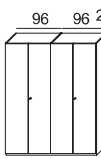
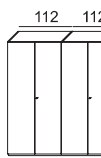
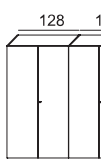
 L. cm 194,5	230,8	CB3D02		
	246,8	CB4D02		
	261,6	CB6D02		
	294,8	CB9D02		
 L. cm 226,5	230,8	CB3E02		
	246,8	CB4E02		
	261,6	CB6E02		
	294,8	CB9E02		
 L. cm 258,5	230,8	CB3F02		
	246,8	CB4F02		
	261,6	CB6F02		
	294,8	CB9F02		

6 ANTE

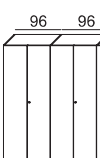
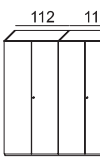
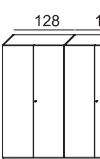
 L. cm 290,5	230,8	CB3M02		
	246,8	CB4M02		
	261,6	CB6M02		
	294,8	CB9M02		
 L. cm 338,5	230,8	CB3N02		
	246,8	CB4N02		
	261,6	CB6N02		
	294,8	CB9N02		
 L. cm 386,5	230,8	CB3P02		
	246,8	CB4P02		
	261,6	CB6P02		
	294,8	CB9P02		

Moduli armadio battente ANTA ORIZZONTE

Il prezzo del modulo comprende:
 - 1 fianco struttura Sp. cm 2,5
 - 1 ripiano interno Sp. cm 4

Escluse maniglie

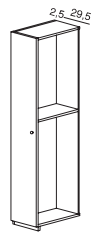

L. cm 32

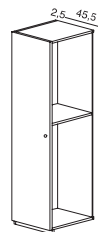

L. cm 48

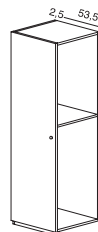

L. cm 56

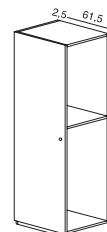

L. cm 64

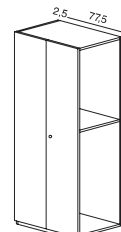

L. cm 80

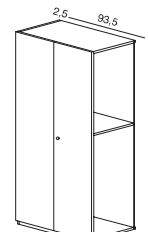

L. cm 96

H. 230,8	Codice	B3302	B3402	B3502	B3602	B3802	B3902
Essenza 1							
Essenza 2							

H. 246,8	B4302	B4402	B4502	B4602	B4802	B4902
Essenza 1						
Essenza 2						

H. 261,6	B6302	B6402	B6502	B6602	B6802	B6902
Essenza 1						
Essenza 2						

H. 294,8	B9302	B9402	B9502	B9602	B9802	B9902
Essenza 1						
Essenza 2						

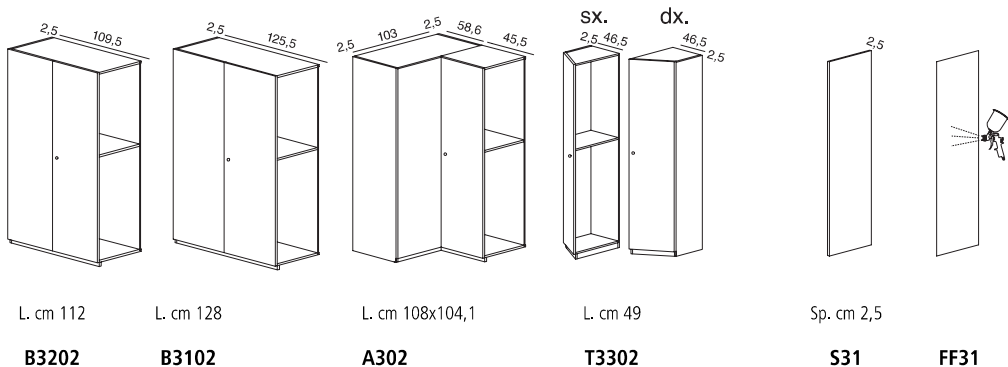

Fianco terminale in melaminico
 Supplemento finitura fianchi esterni (cad.)

CASSETTIERE interne 4 cassetti
 con guide ammortizzate

Per estrazione totale aggiungere per cassetto +



- L. cm 45,5
- L. cm 53,5
- L. cm 61,5
- L. cm 77,5
- L. cm 93,5
- L. cm 109,5
- L. cm 125,5

B4202 B4102 A402 T4302 S45 FF46

Ripiani interni



Sp. 2,5 | Sp. 4

- L. 29,5
- L. 45,5
- L. 53,5
- L. 61,5
- L. 77,5
- L. 93,5
- L. 109,5
- L. 125,5
- Per angolare
- Per terminale

B6202 B6102 A602 T6302 S62 FF62

Tubi appendiabiti alluminio

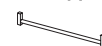

B9202 B9102 A902 T9302 S95 FF95

- L. 29,5
- L. 45,5
- L. 53,5
- L. 61,5
- L. 77,5
- L. 93,5
- L. 109,5
- L. 125,5
- Per angolare

ANTA TRATTINO



Maniglia incassata H.30 L. cm 2
H. totale da terra cm 118,6



Anta battente TRATTINO - Caratteristiche, modularità e finiture



Anta Battente TRATTINO

Anta spessore mm 25 in agglomerato superleggero con 6 cerniere per anta con apertura a 110° con chiusura rallentata. Nei moduli a due ante è applicato un profilo parapolvere sull'anta di sinistra. Maniglia in alluminio H. 31 cm finitura Laccato opaco incassata sul filo dell'anta. Nelle colonne con doppia anta la maniglia è incassata nella **sola anta destra**.

Finiture previste anta TRATTINO

Essenze nostro campionario impiallacciato verticale
Laccato opaco

LARGHEZZA

- Moduli con struttura P. cm 58,6
- Moduli con struttura P. cm 42,6

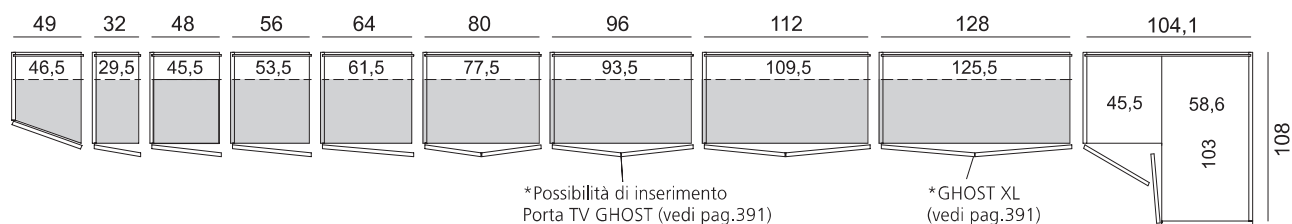

ALTEZZA

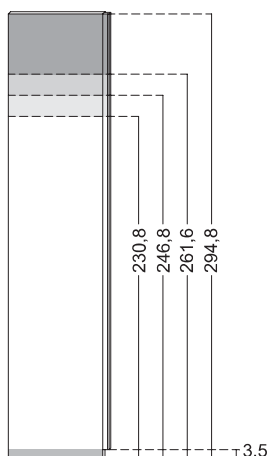

PROFONDITÀ

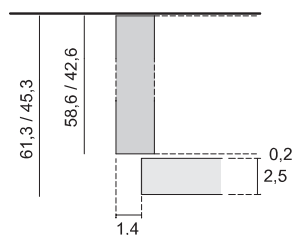

Riduzioni struttura

RIDUZIONE in LARGHEZZA Euro

Il prezzo della riduzione è comprensivo dei tagli:

- Coperchio Euro
- Base Euro
- 1 ripiano Euro
- Schienale Euro
- Anta Euro

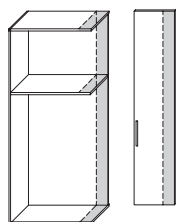

RIDUZIONE in PROFONDITÀ Euro

Il prezzo della riduzione è comprensivo dei tagli e foratura supplementare:

- Coperchio Euro
- Base Euro
- 1 ripiano Euro
- 1 fianco Euro

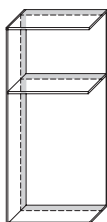

RIDUZIONE in ALTEZZA Euro

Il prezzo della riduzione è comprensivo dei tagli:

- Fianco Euro
- Schienale Euro
- Anta Euro
- Anta con taglio inclinato Euro

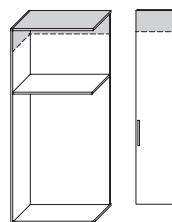

Anta battente TRATTINO - Composizioni

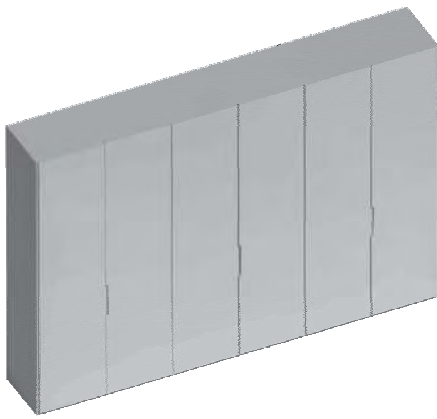

- Armadi P. cm 45,3 stesso prezzo
- Prezzi comprensivi di finitura fianchi come anta
- Incluso un ripiano strutturale Sp. cm 4 a modulo
- Possibilità di inserimento **PORTA TV GHOST** vedi pag.391

3 ANTE

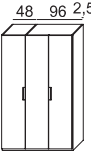
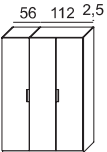
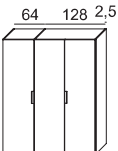
	H.	Codice	Essenza 1	Essenza 2	Laccato Opaco
 L. cm 146,5	230,8	CB3A03			
	246,8	CB4A03			
	261,6	CB6A03			
	294,8	CB9A03			
 L. cm 170,5	230,8	CB3B03			
	246,8	CB4B03			
	261,6	CB6B03			
	294,8	CB9B03			
 L. cm 194,5	230,8	CB3C03			
	246,8	CB4C03			
	261,6	CB6C03			
	294,8	CB9C03			

5 ANTE

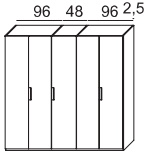
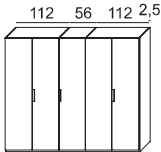
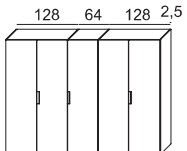
	H.	Codice	Essenza 1	Essenza 2	Laccato Opaco
 L. cm 242,5	230,8	CB3G03			
	246,8	CB4G03			
	261,6	CB6G03			
	294,8	CB9G03			
 L. cm 282,5	230,8	CB3H03			
	246,8	CB4H03			
	261,6	CB6H03			
	294,8	CB9H03			
 L. cm 322,5	230,8	CB3L03			
	246,8	CB4L03			
	261,6	CB6L03			
	294,8	CB9L03			

4 ANTE

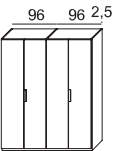
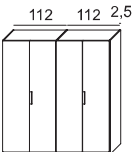
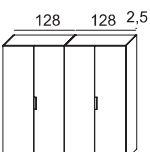
 L. cm 194,5	230,8	CB3D03			
	246,8	CB4D03			
	261,6	CB6D03			
	294,8	CB9D03			
 L. cm 226,5	230,8	CB3E03			
	246,8	CB4E03			
	261,6	CB6E03			
	294,8	CB9E03			
 L. cm 258,5	230,8	CB3F03			
	246,8	CB4F03			
	261,6	CB6F03			
	294,8	CB9F03			

6 ANTE

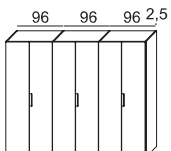
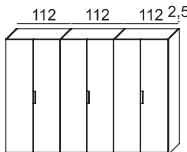
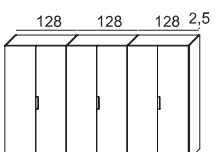
 L. cm 290,5	230,8	CB3M03			
	246,8	CB4M03			
	261,6	CB6M03			
	294,8	CB9M03			
 L. cm 338,5	230,8	CB3N03			
	246,8	CB4N03			
	261,6	CB6N03			
	294,8	CB9N03			
 L. cm 386,5	230,8	CB3P03			
	246,8	CB4P03			
	261,6	CB6P03			
	294,8	CB9P03			

Moduli armadio battente ANTA TRATTINO

Il prezzo del modulo comprende:

- 1 fianco struttura Sp. cm 2,5
- 1 ripiano interno Sp. cm 4

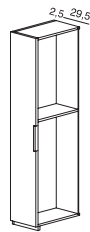

L. cm 32

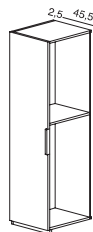

L. cm 48

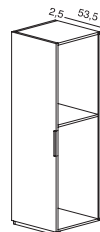

L. cm 56

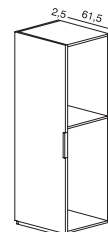

L. cm 64

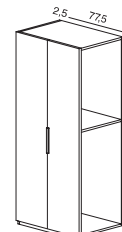

L. cm 80

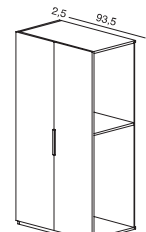

L. cm 96

H. 230,8	Codice	B3303	B3403	B3503	B3603	B3803	B3903
	Essenza 1	_____					
	Essenza 2	_____					
	Laccato opaco	_____					

H. 246,8	B4303	B4403	B4503	B4603	B4803	B4903	
	Essenza 1	_____					
	Essenza 2	_____					
	Laccato opaco	_____					

H. 261,6	B6303	B6403	B6503	B6603	B6803	B6903	
	Essenza 1	_____					
	Essenza 2	_____					
	Laccato opaco	_____					

H. 294,8	B9303	B9403	B9503	B9603	B9803	B9903	
	Essenza 1	_____					
	Essenza 2	_____					
	Laccato opaco	_____					

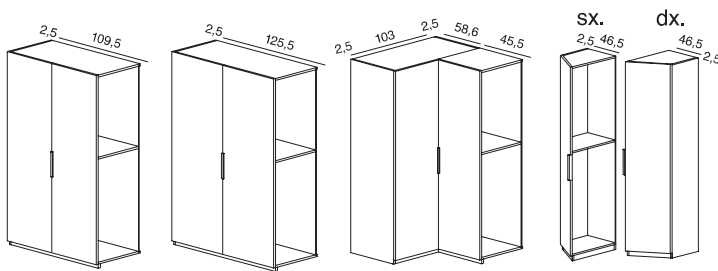

Fianco terminale
in melaminico

Supplemento
finitura fianchi
esterni (cad.)

L. cm 112

L. cm 128

L. cm 108x104,1

L. cm 49

Sp. cm 2,5

B3203

B3103

A303

T3303

S31

FF31

CASSETTIERE interne 4 cassetti
con guide ammortizzate

Per estrazione totale aggiungere
per cassetto +



- L. cm 45,5
- L. cm 53,5
- L. cm 61,5
- L. cm 77,5
- L. cm 93,5
- L. cm 109,5
- L. cm 125,5

B4203

B4103

A403

T4303

S46

FF46

Ripiani interni



Sp. 2,5 | Sp. 4

- L. 29,5
- L. 45,5
- L. 53,5
- L. 61,5
- L. 77,5
- L. 93,5
- L. 109,5
- L. 125,5
- Per angolare
- Per terminale

B6203

B6103

A603

T6303

S62

FF62

B9203

B9103

A903

T9303

S95

FF95

Tubi appendiabiti alluminio



- L. 29,5
- L. 45,5
- L. 53,5
- L. 61,5
- L. 77,5
- L. 93,5
- L. 109,5
- L. 125,5
- Per angolare

ANTA TRATTO

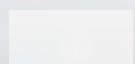

Maniglia incassata H. 100 L. cm 2
H. totale da terra cm 103,6

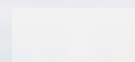

Anta battente TRATTO - Caratteristiche, modularità e finiture



Anta Battente TRATTO

Anta spessore mm 25 in agglomerato superleggero con 6 cerniere per anta con apertura a 110° con chiusura rallentata. Nei moduli a due ante è applicato un profilo parapolvere sull'anta di sinistra. Maniglia in alluminio H. cm 100 finitura Laccato opaco incassata sul filo dell'anta. Nelle colonne con doppia anta la maniglia è incassata nella **sola anta destra**.

Finiture previste anta TRATTO

Essenze nostro campionario impiallacciato verticale
Laccato opaco

LARGHEZZA

- Moduli con struttura P. cm 58,6
- Moduli con struttura P. cm 42,6

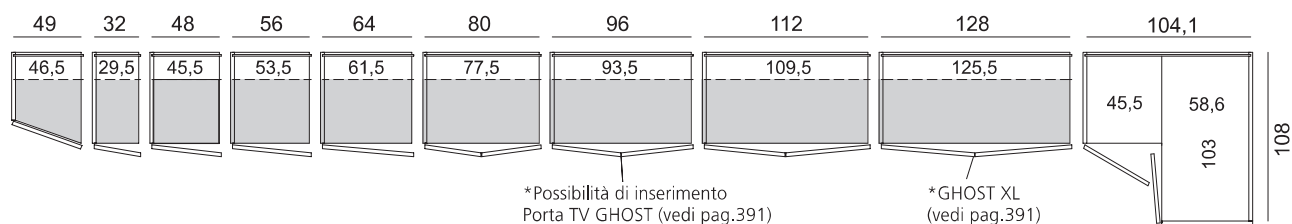

ALTEZZA

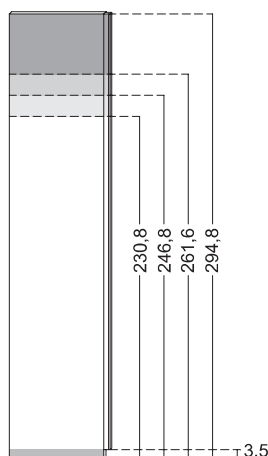

PROFONDITÀ

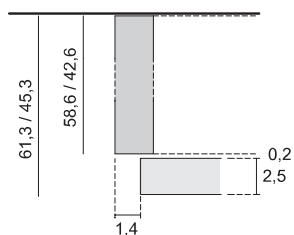

Riduzioni struttura

RIDUZIONE in LARGHEZZA Euro

Il prezzo della riduzione è comprensivo dei tagli:

- Coperchio	Euro
- Base	Euro
- 1 ripiano	Euro
- Schienale	Euro
- Anta	Euro

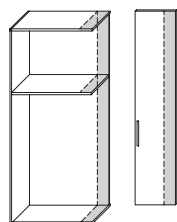

RIDUZIONE in PROFONDITÀ Euro

Il prezzo della riduzione è comprensivo dei tagli e foratura supplementare:

- Coperchio	Euro
- Base	Euro
- 1 ripiano	Euro
- 1 fianco	Euro

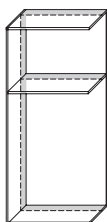

RIDUZIONE in ALTEZZA Euro

Il prezzo della riduzione è comprensivo dei tagli:

- Fianco	Euro
- Schienale	Euro
- Anta	Euro
- Anta con taglio inclinato	Euro

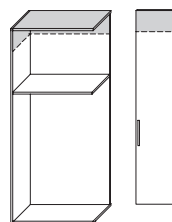

Anta battente TRATTO - Composizioni

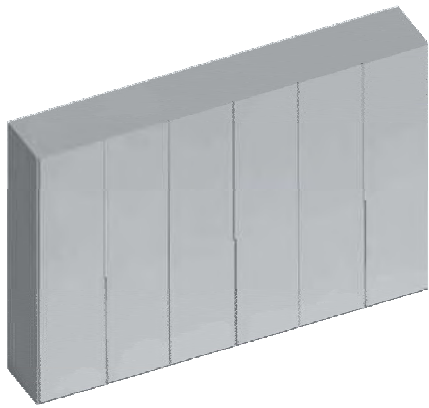

- Armadi P. cm 45,3 stesso prezzo
- Prezzi comprensivi di finitura fianchi come anta
- Incluso un ripiano strutturale Sp. cm 4 a modulo
- Possibilità di inserimento **PORTA TV GHOST** vedi pag.391

3 ANTE

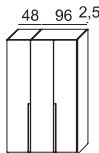
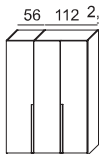
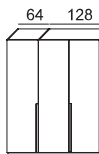
	H.	Codice	Essenza 1	Essenza 2	Laccato Opaco
 L. cm 146,5	230,8	CB3A04			
	246,8	CB4A04			
	261,6	CB6A04			
	294,8	CB9A04			
 L. cm 170,5	230,8	CB3B04			
	246,8	CB4B04			
	261,6	CB6B04			
	294,8	CB9B04			
 L. cm 194,5	230,8	CB3C04			
	246,8	CB4C04			
	261,6	CB6C04			
	294,8	CB9C04			

5 ANTE

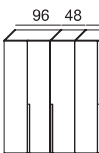
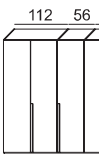
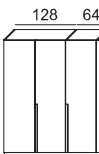
	H.	Codice	Essenza 1	Essenza 2	Laccato Opaco
 L. cm 242,5	230,8	CB3G04			
	246,8	CB4G04			
	261,6	CB6G04			
	294,8	CB9G04			
 L. cm 282,5	230,8	CB3H04			
	246,8	CB4H04			
	261,6	CB6H04			
	294,8	CB9H04			
 L. cm 322,5	230,8	CB3L04			
	246,8	CB4L04			
	261,6	CB6L04			
	294,8	CB9L04			

4 ANTE

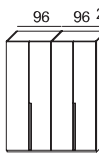
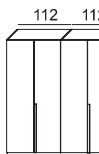
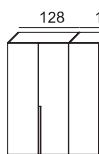
 L. cm 194,5	230,8	CB3D04			
	246,8	CB4D04			
	261,6	CB6D04			
	294,8	CB9D04			
 L. cm 226,5	230,8	CB3E04			
	246,8	CB4E04			
	261,6	CB6E04			
	294,8	CB9E04			
 L. cm 258,5	230,8	CB3F04			
	246,8	CB4F04			
	261,6	CB6F04			
	294,8	CB9F04			

6 ANTE

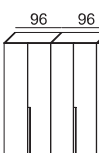
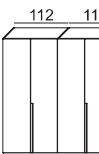
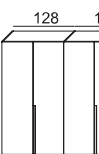
 L. cm 290,5	230,8	CB3M04			
	246,8	CB4M04			
	261,6	CB6M04			
	294,8	CB9M04			
 L. cm 338,5	230,8	CB3N04			
	246,8	CB4N04			
	261,6	CB6N04			
	294,8	CB9N04			
 L. cm 386,5	230,8	CB3P04			
	246,8	CB4P04			
	261,6	CB6P04			
	294,8	CB9P04			

Moduli armadio battente ANTA TRATTO

Il prezzo del modulo comprende:

- 1 fianco struttura Sp. cm 2,5
- 1 ripiano interno Sp. cm 4

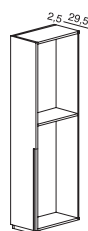

L. cm 32

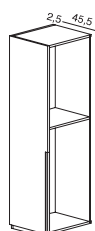

L. cm 48

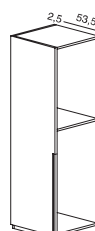

L. cm 56

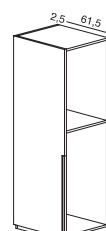

L. cm 64

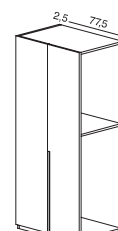

L. cm 80

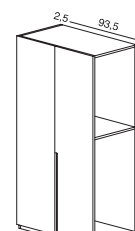

L. cm 96

H. 230,8

Codice

B3304

B3404

B3504

B3604

B3804

B3904

Essenza 1

Essenza 2

Laccato opaco

H. 246,8

B4304

B4404

B4504

B4604

B4804

B4904

Essenza 1

Essenza 2

Laccato opaco

H. 261,6

B6304

B6404

B6504

B6604

B6804

B6904

Essenza 1

Essenza 2

Laccato opaco

H. 294,8

B9304

B9404

B9504

B9604

B9804

B9904

Essenza 1

Essenza 2

Laccato opaco

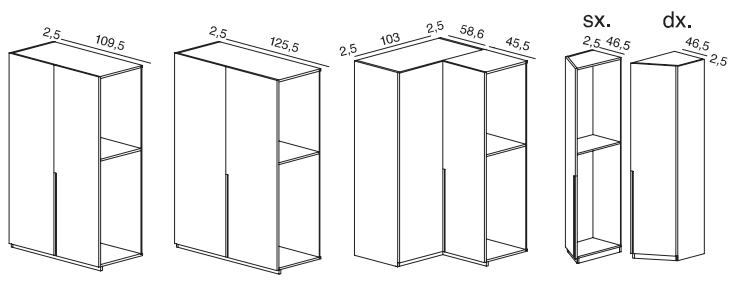

Fianco terminale
in melaminico

Supplemento
finitura fianchi
esterni (cad.)

L. cm 112

L. cm 128

L. cm 108x104,1

L. cm 49

Sp. cm 2,5

B3204

B3104

A304

T3304

S31

FF31

CASSETTIERE interne 4 cassetti
con guide ammortizzate

Per estrazione totale aggiungere
per cassetto



- L. cm 45,5
- L. cm 53,5
- L. cm 61,5
- L. cm 77,5
- L. cm 93,5
- L. cm 109,5
- L. cm 125,5

B4204

B4104

A404

T4304

S46

FF46

Ripiani interni



Sp. 2,5 | Sp. 4

- L. 29,5
- L. 45,5
- L. 53,5
- L. 61,5
- L. 77,5
- L. 93,5
- L. 109,5
- L. 125,5
- Per angolare
- Per terminale

B6204

B6104

A604

T6304

S62

FF62

Tubi appendiabiti alluminio



- L. 29,5
- L. 45,5
- L. 53,5
- L. 61,5
- L. 77,5
- L. 93,5
- L. 109,5
- L. 125,5
- Per angolare

B9204

B9104

A904

T9304

S95

FF95

ANTA UP DOWN

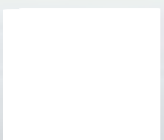

Maniglia incassata H. 156 L. cm 2
H. totale da terra cm 159,6

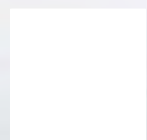

Anta battente UP and DOWN - Caratteristiche, modularità e finiture



Anta Battente UP and DOWN

Anta spessore mm 25 in agglomerato superleggero con 6 cerniere per anta con apertura a 110° con chiusura rallentata. Nei moduli a due ante è applicato un profilo parapolvere sull'anta di sinistra. Maniglia in alluminio H. cm 157 finitura Laccato opaco incassata sul filo dell'anta posizionata a richiesta dall'alto verso il basso oppure dal basso verso l'alto. Nelle colonne con doppia anta la maniglia è incassata nella **sola anta destra.**

Finiture previste anta UP and DOWN Essenze nostro campionario impiallacciato verticale
Laccato opaco

LARGHEZZA

- Moduli con struttura P. cm 58,6
- Moduli con struttura P. cm 42,6

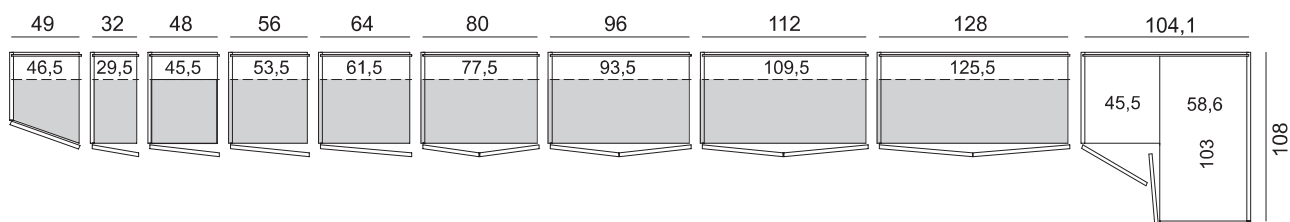

ALTEZZA

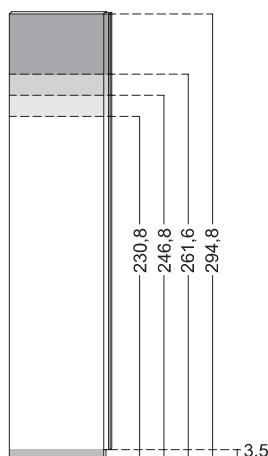

PROFONDITÀ

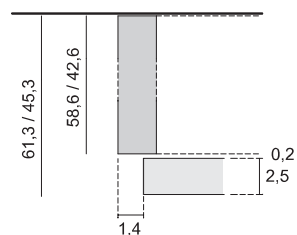

Riduzioni struttura

RIDUZIONE in LARGHEZZA Euro
Il prezzo della riduzione è comprensivo dei tagli:

- Coperchio	Euro
- Base	Euro
- 1 ripiano	Euro
- Schienale	Euro
- Anta	Euro

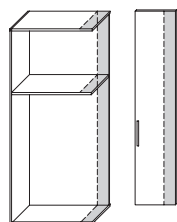

RIDUZIONE in PROFONDITÀ Euro
Il prezzo della riduzione è comprensivo dei tagli e foratura supplementare:

- Coperchio	Euro
- Base	Euro
- 1 ripiano	Euro
- 1 fianco	Euro

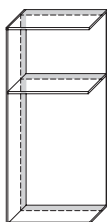

RIDUZIONE in ALTEZZA Euro
Il prezzo della riduzione è comprensivo dei tagli:

- Fianco	Euro
- Schienale	Euro
- Anta	Euro
- Anta con taglio inclinato	Euro

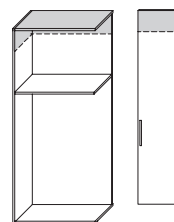

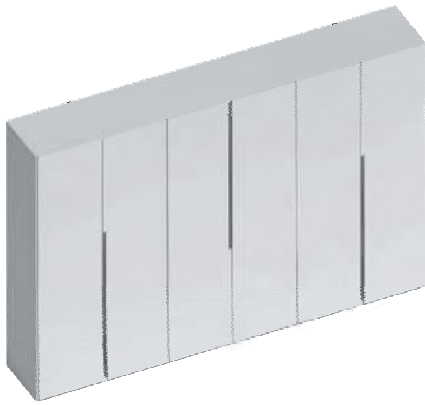

Anta battente UP and DOWN - Composizioni



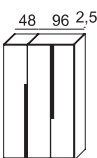
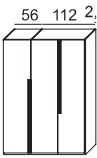

- Armadi P. cm 45,3 stesso prezzo
- Prezzi comprensivi di finitura fianchi come anta
- Incluso un ripiano strutturale Sp. cm 4 a modulo

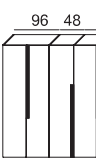
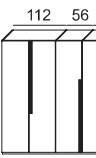

3 ANTE

	H.	Codice	Essenza 1	Essenza 2	Laccato Opaco
 L. cm 146,5	230,8	CB3A05			
	246,8	CB4A05			
	261,6	CB6A05			
	294,8	CB9A05			
 L. cm 170,5	230,8	CB3B05			
	246,8	CB4B05			
	261,6	CB6B05			
	294,8	CB9B05			
 L. cm 194,5	230,8	CB3C05			
	246,8	CB4C05			
	261,6	CB6C05			
	294,8	CB6C05			

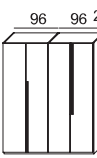

5 ANTE

	H.	Codice	Essenza 1	Essenza 2	Laccato Opaco
 L. cm 242,5	230,8	CB3G05			
	246,8	CB4G05			
	261,6	CB6G05			
	294,8	CB9G05			
 L. cm 282,5	230,8	CB3H05			
	246,8	CB4H05			
	261,6	CB6H05			
	294,8	CB9H05			
 L. cm 322,5	230,8	CB3L05			
	246,8	CB4L05			
	261,6	CB6L05			
	294,8	CB9L05			

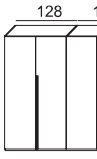
4 ANTE

 L. cm 194,5	230,8	CB3D05			
	246,8	CB4D05			
	261,6	CB6D05			
	294,8	CB9D05			
 L. cm 226,5	230,8	CB3E05			
	246,8	CB4E05			
	261,6	CB6E05			
	294,8	CB9E05			
 L. cm 258,5	230,8	CB3F05			
	246,8	CB4F05			
	261,6	CB6F05			
	294,8	CB9F05			

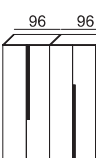
6 ANTE

 L. cm 290,5	230,8	CB3M05			
	246,8	CB4M05			
	261,6	CB6M05			
	294,8	CB9M05			
 L. cm 338,5	230,8	CB3N05			
	246,8	CB4N05			
	261,6	CB6N05			
	294,8	CB9N05			
 L. cm 386,5	230,8	CB3P05			
	246,8	CB4P05			
	261,6	CB6P05			
	294,8	CB9P05			

Moduli armadio battente ANTA UP and DOWN

Il prezzo del modulo comprende:

- 1 fianco struttura Sp. cm 2,5
- 1 ripiano interno Sp. cm 4

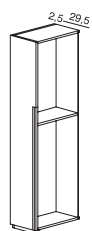

L. cm 32

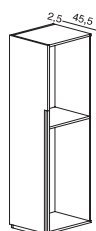

L. cm 48

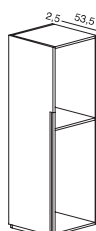

L. cm 56

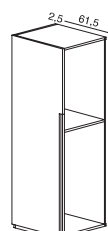

L. cm 64

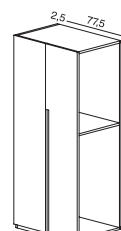

L. cm 80

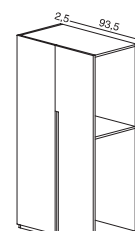

L. cm 96

H. 230,8	Codice	B3305	B3405	B3505	B3605	B3805	B3905
Essenza 1							
Essenza 2							
Laccato opaco							

H. 246,8	B4305	B4405	B4505	B4605	B4805	B4905
Essenza 1						
Essenza 2						
Laccato opaco						

H. 261,6	B6305	B6405	B6505	B6605	B6805	B6905
Essenza 1						
Essenza 2						
Laccato opaco						

H. 294,8	B9305	B9405	B9505	B9605	B9805	B9905
Essenza 1						
Essenza 2						
Laccato opaco						

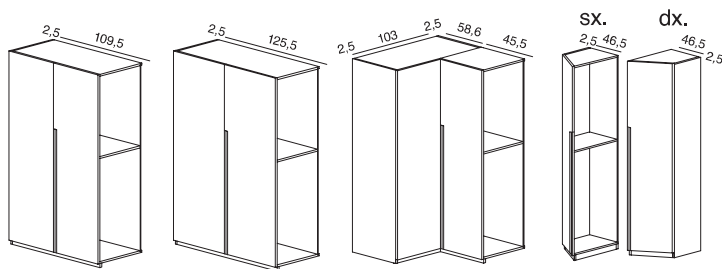

Fianco terminale
in melaminico

Supplemento
finitura fianchi
esterni (cad.)

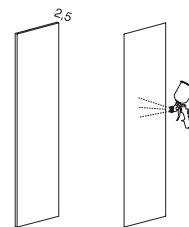

L. cm 112

L. cm 128

L. cm 108x104,1

L. cm 49

Sp. cm 2,5

B3205

B3105

A305

T3305

S31

FF31

CASSETTIERE interne 4 cassetti
con guide ammortizzate

Per estrazione totale aggiungere
per cassetto



- L. cm 45,5
- L. cm 53,5
- L. cm 61,5
- L. cm 77,5
- L. cm 93,5
- L. cm 109,5
- L. cm 125,5

B4205

B4105

A405

T4305

S46

FF46

Ripiani interni



Sp. 2,5 | Sp. 4

- L. 29,5
- L. 45,5
- L. 53,5
- L. 61,5
- L. 77,5
- L. 93,5
- L. 109,5
- L. 125,5
- Per angolare
- Per terminale

B6205

B6105

A605

T6305

S62

FF62

Tubi appendiabiti alluminio

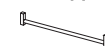

B9205

B9105

A905

T9305

S95

FF95

- L. 29,5
- L. 45,5
- L. 53,5
- L. 61,5
- L. 77,5
- L. 93,5
- L. 109,5
- L. 125,5
- Per angolare

ANTA DREAM



Maniglia incassata tutta altezza L. cm 2

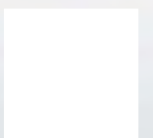

Anta battente DREAM - Caratteristiche, modularità e finiture



Anta Battente DREAM

Anta spessore mm 25 in agglomerato superleggero con 6 cerniere per anta con apertura a 110° con chiusura rallentata.
 Nei moduli a due ante è applicato un profilo parapolvere sull'anta di sinistra.
 Maniglia in alluminio a tutta altezza finitura Laccato opaco incassata sul filo dell'anta.
 Nelle colonne con doppia anta la maniglia è incassata nella **sola anta destra**.

Finiture previste anta DREAM

Essenze nostro campionario impiallacciato verticale
 Laccato opaco

LARGHEZZA

- Moduli con struttura P. cm 58,6
- Moduli con struttura P. cm 42,6

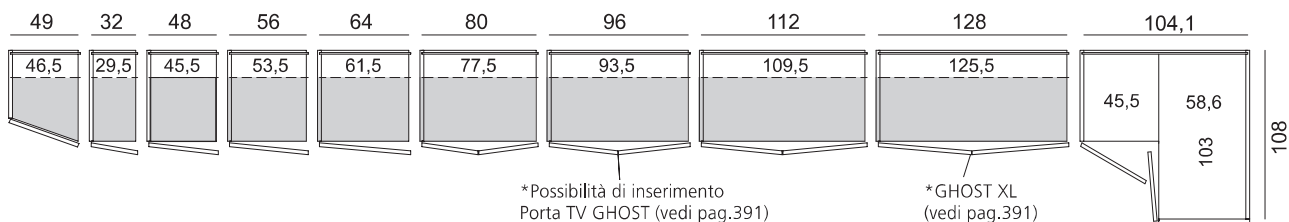

ALTEZZA

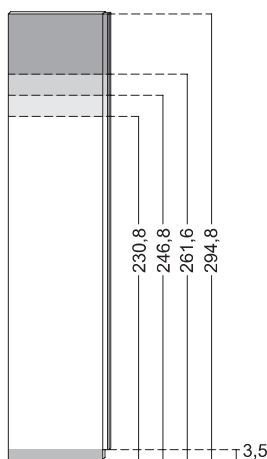

PROFONDITÀ

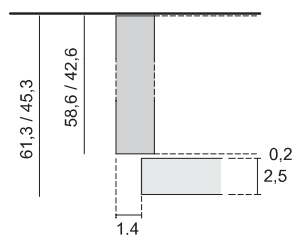

Riduzioni struttura

RIDUZIONE in LARGHEZZA

Il prezzo della riduzione è comprensivo dei tagli:

- Coperchio
- Base
- 1 ripiano
- Schienale

- Anta

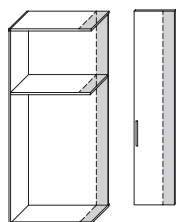

RIDUZIONE in PROFONDITÀ

Il prezzo della riduzione è comprensivo dei tagli e foratura supplementare:

- Coperchio
- Base
- 1 ripiano
- 1 fianco

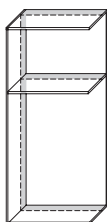

RIDUZIONE in ALTEZZA

Il prezzo della riduzione è comprensivo dei tagli:

- Fianco
- Schienale

- Anta

- Anta con taglio inclinato

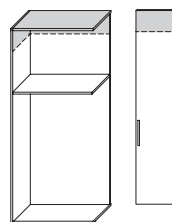

Anta battente DREAM - Composizioni

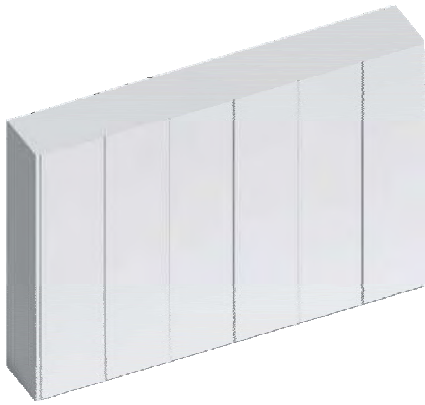

- Armadi P. cm 45,3 stesso prezzo
- Prezzi comprensivi di finitura fianchi come anta
- Incluso un ripiano strutturale Sp. cm 4 a modulo
- Possibilità di inserimento **PORTA TV GHOST** vedi pag.391

3 ANTE

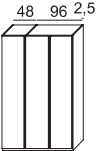
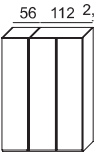
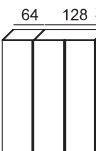
	H.	Codice	Essenza 1	Essenza 2	Laccato Opaco
 L. cm 146,5	230,8	CB3A07			
	246,8	CB4A07			
	261,6	CB6A07			
	294,8	CB9A07			
 L. cm 170,5	230,8	CB3B07			
	246,8	CB4B07			
	261,6	CB6B07			
	294,8	CB9B07			
 L. cm 194,5	230,8	CB3C07			
	246,8	CB4C07			
	261,6	CB6C07			
	294,8	CB9C07			

5 ANTE

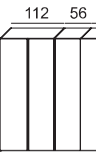
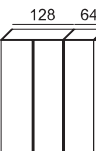
	H.	Codice	Essenza 1	Essenza 2	Laccato Opaco
 L. cm 242,5	230,8	CB3G07			
	246,8	CB4G07			
	261,6	CB6G07			
	294,8	CB9G07			
 L. cm 282,5	230,8	CB3H07			
	246,8	CB4H07			
	261,6	CB6H07			
	294,8	CB9H07			
 L. cm 322,5	230,8	CB3L07			
	246,8	CB4L07			
	261,6	CB6L07			
	294,8	CB9L07			

4 ANTE

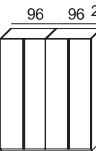
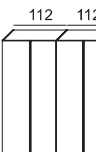
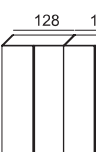
 L. cm 194,5	230,8	CB3D07			
	246,8	CB4D07			
	261,6	CB6D07			
	294,8	CB9D07			
 L. cm 226,5	230,8	CB3E07			
	246,8	CB4E07			
	261,6	CB6E07			
	294,8	CB9E07			
 L. cm 258,5	230,8	CB3F07			
	246,8	CB4F07			
	261,6	CB6F07			
	294,8	CB9F07			

6 ANTE

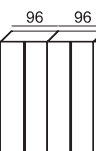
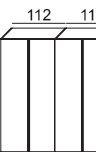
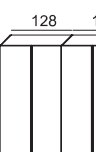
 L. cm 290,5	230,8	CB3M07			
	246,8	CB4M07			
	261,6	CB6M07			
	294,8	CB9M07			
 L. cm 338,5	230,8	CB3N07			
	246,8	CB4N07			
	261,6	CB6N07			
	294,8	CB9N07			
 L. cm 386,5	230,8	CB3P07			
	246,8	CB4P07			
	261,6	CB6P07			
	294,8	CB9P07			

Moduli armadio battente ANTA DREAM

Il prezzo del modulo comprende:

- 1 fianco struttura Sp. cm 2,5
- 1 ripiano interno Sp. cm 4

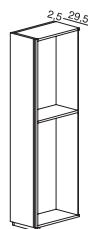

L. cm 32

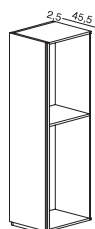

L. cm 48

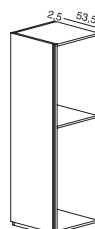

L. cm 56

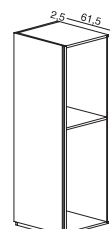

L. cm 64

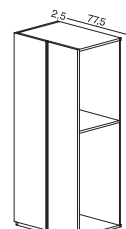

L. cm 80

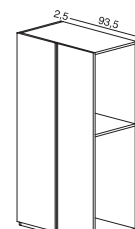

L. cm 96

H. 230,8

Codice

B3307

B3407

B3507

B3607

B3807

B3907

Essenza 1

Essenza 2

Laccato opaco

H. 246,8

B4307

B4407

B4507

B4607

B4807

B4907

Essenza 1

Essenza 2

Laccato opaco

H. 261,6

B6307

B6407

B6507

B6607

B6807

B6907

Essenza 1

Essenza 2

Laccato opaco

H. 294,8

B9307

B9407

B9507

B9607

B9807

B9907

Essenza 1

Essenza 2

Laccato opaco

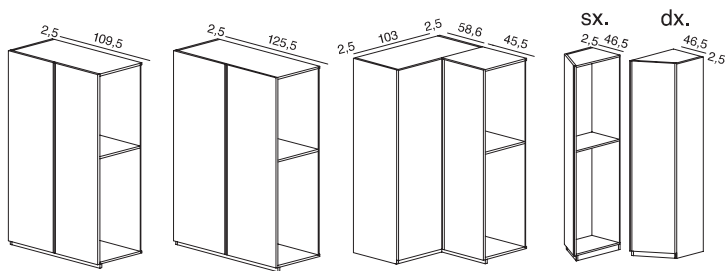

Fianco terminale
in melaminico

Supplemento
finitura fianchi
esterni (cad.)

L. cm 112

L. cm 128

L. cm 108x104,1

L. cm 49

Sp. cm 2,5

B3207

B3107

A307

T3307

S31

FF31

CASSETTIERE interne 4 cassetti
con guide ammortizzate

Per estrazione totale aggiungere
per cassetto +



- L. cm 45,5
- L. cm 53,5
- L. cm 61,5
- L. cm 77,5
- L. cm 93,5
- L. cm 109,5
- L. cm 125,5

B4207

B4107

A407

T4307

S46

FF46

Ripiani interni



Sp. 2,5 | Sp. 4

- L. 29,5
- L. 45,5
- L. 53,5
- L. 61,5
- L. 77,5
- L. 93,5
- L. 109,5
- L. 125,5
- Per angolare
- Per terminale

B6207

B6107

A607

T6307

S62

FF62

Tubi appendiabiti alluminio



B9207

B9107

A907

T9307

S95

FF95

- L. 29,5
- L. 45,5
- L. 53,5
- L. 61,5
- L. 77,5
- L. 93,5
- L. 109,5
- L. 125,5
- Per angolare

ANTA INSERTO

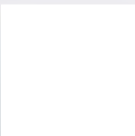

Maniglia con inserto in diverse finiture H.100 L. cm 7
H. totale da terra cm 103,6

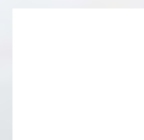
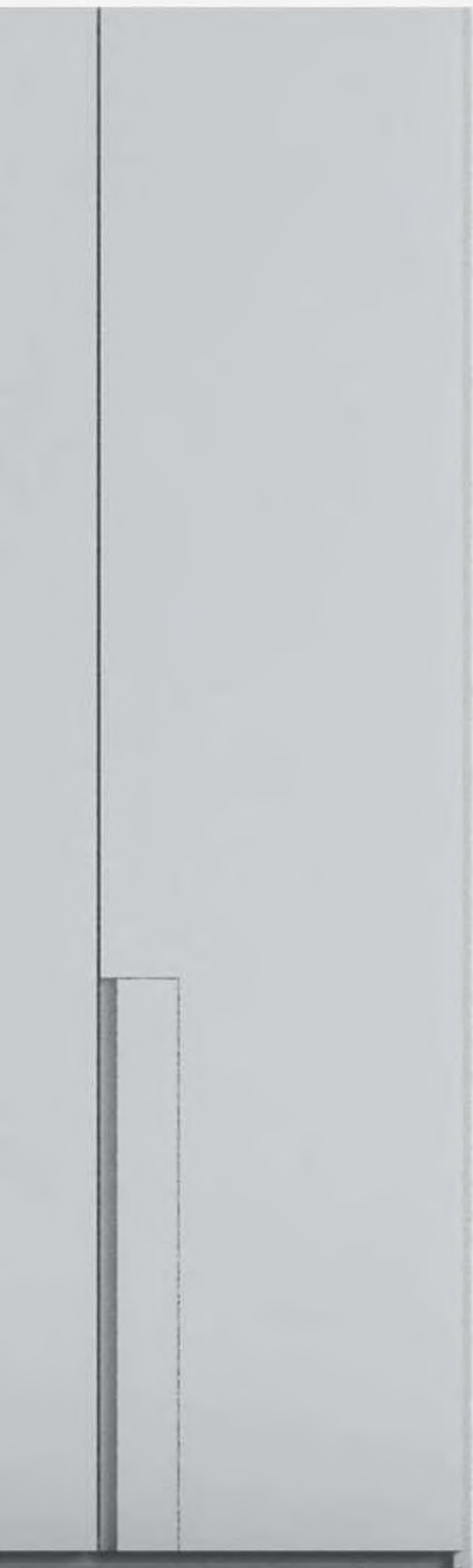

Anta battente INSERTO - Caratteristiche, modularità e finiture

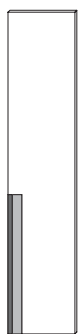

Anta Battente INSERTO

Anta spessore mm 25 in agglomerato superleggero con 6 cerniere per anta con apertura a 110° con chiusura rallentata.
 Nei moduli a due ante è applicato un profilo parapolvere sull'anta di sinistra.
 Maniglia in alluminio presa laterale L. cm 7 - H. cm 100 incassata sul filo dell'anta e rivestita con pannello in legno nelle varie finiture previste a campionario, vetro laccato o specchio
 Nelle colonne con doppia anta la maniglia è incassata nella **sola anta destra**.

Finiture previste anta INSERTO

Essenze nostro campionario impiallacciato verticale
 Laccato opaco

Finiture previste per **personalizzazione maniglia**

Essenze nostro campionario impiallacciate orizzontale
 Laccato opaco colori nostro campionario
 Vetro lucido extralight laccato opaco nostro campionario
 Vetro satinato opaco laccato opaco colori nostro campionario
 Specchio chiaro / Specchio grigio

LARGHEZZA

- Moduli con struttura P. cm 58,6
- Moduli con struttura P. cm 42,6

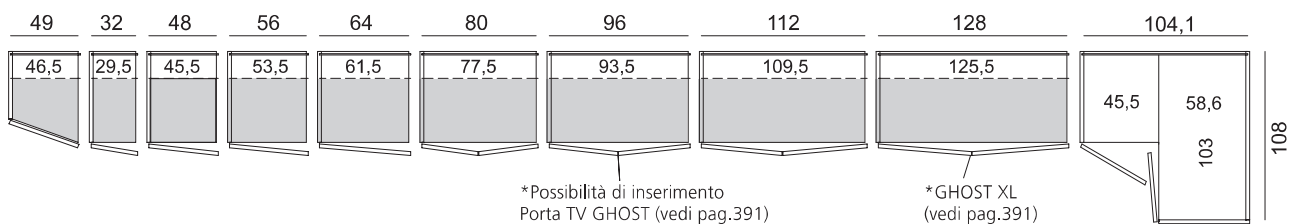

ALTEZZA

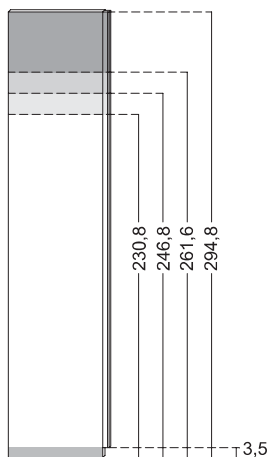

PROFONDITÀ

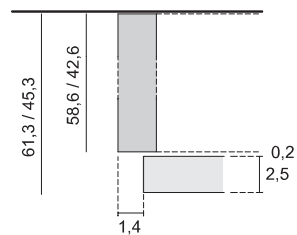

Riduzioni struttura

RIDUZIONE in LARGHEZZA

Il prezzo della riduzione è comprensivo dei tagli:

- Coperchio
- Base
- 1 ripiano
- Schienale

- Anta

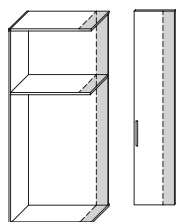

RIDUZIONE in PROFONDITÀ

Il prezzo della riduzione è comprensivo dei tagli e foratura supplementare:

- Coperchio
- Base
- 1 ripiano
- 1 fianco

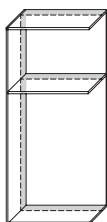

RIDUZIONE in ALTEZZA

Il prezzo della riduzione è comprensivo dei tagli:

- Fianco
- Schienale

- Anta

- Anta con taglio inclinato

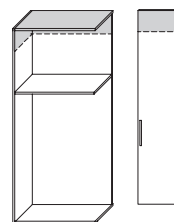

Anta battente INSERTO - Composizioni

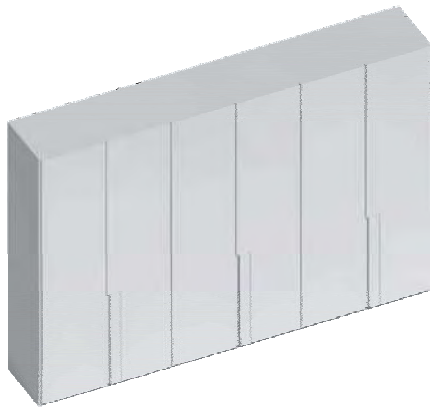

- Armadi P. cm 45,3 stesso prezzo
- Prezzi comprensivi di finitura fianchi come anta
- Incluso un ripiano strutturale Sp. cm 4 a modulo
- Possibilità di inserimento **PORTA TV GHOST** vedi pag.391

3 ANTE

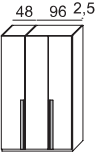
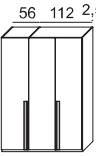
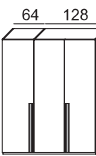
	H.	Codice	Essenza 1	Essenza 2	Laccato Opaco
 L. cm 146,5	230,8	CB3A06			
	246,8	CB4A06			
	261,6	CB6A06			
	294,8	CB9A06			
 L. cm 170,5	230,8	CB3B06			
	246,8	CB4B06			
	261,6	CB6B06			
	294,8	CB9B06			
 L. cm 194,5	230,8	CB3C06			
	246,8	CB4C06			
	261,6	CB6C06			
	294,8	CB9C06			

5 ANTE

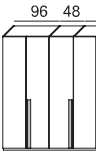
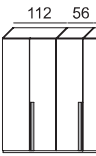
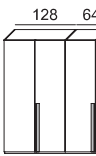
	H.	Codice	Essenza 1	Essenza 2	Laccato Opaco
 L. cm 242,5	230,8	CB3G06			
	246,8	CB4G06			
	261,6	CB6G06			
	294,8	CB9G06			
 L. cm 282,5	230,8	CB3H06			
	246,8	CB4H06			
	261,6	CB6H06			
	294,8	CB9H06			
 L. cm 322,5	230,8	CB3L06			
	246,8	CB4L06			
	261,6	CB6L06			
	294,8	CB9L06			

4 ANTE

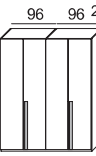
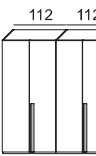
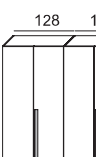
 L. cm 194,5	230,8	CB3D06			
	246,8	CB4D06			
	261,6	CB6D06			
	294,8	CB9D06			
 L. cm 226,5	230,8	CB3E06			
	246,8	CB4E06			
	261,6	CB6E06			
	294,8	CB9E06			
 L. cm 258,5	230,8	CB3F06			
	246,8	CB4F06			
	261,6	CB6F06			
	294,8	CB9F06			

6 ANTE

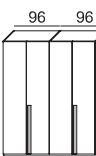
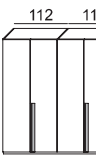
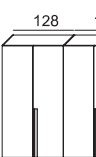
 L. cm 290,5	230,8	CB3M06			
	246,8	CB4M06			
	261,6	CB6M06			
	294,8	CB9M06			
 L. cm 338,5	230,8	CB3N06			
	246,8	CB4N06			
	261,6	CB6N06			
	294,8	CB9N06			
 L. cm 386,5	230,8	CB3P06			
	246,8	CB4P06			
	261,6	CB6P06			
	294,8	CB9P06			

Moduli armadio battente ANTA INSERTO

Il prezzo del modulo comprende:

- 1 fianco struttura Sp. cm 2,5
- 1 ripiano interno Sp. cm 4

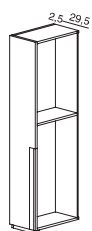

L. cm 32

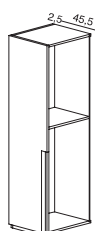

L. cm 48

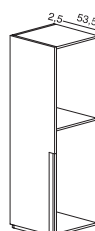

L. cm 56

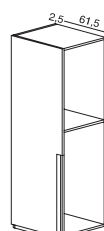

L. cm 64

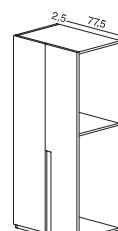

L. cm 80

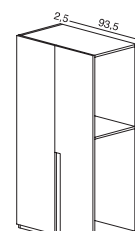

L. cm 96

H. 230,8	Codice	B3306	B3406	B3506	B3606	B3806	B3906
Essenza 1							
Essenza 2							
Laccato opaco							

H. 246,8	B4306	B4406	B4506	B4606	B4806	B4906
Essenza 1						
Essenza 2						
Laccato opaco						

H. 261,6	B6306	B6406	B6506	B6606	B6806	B6906
Essenza 1						
Essenza 2						
Laccato opaco						

H. 294,8	B9306	B9406	B9506	B9606	B9806	B9906
Essenza 1						
Essenza 2						
Laccato opaco						

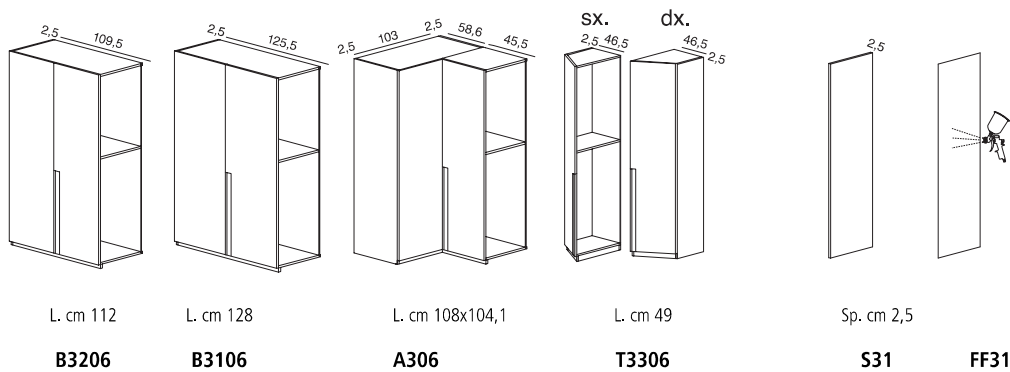

CASSETTIERE interne 4 cassetti
con guide ammortizzate

Per estrazione totale aggiungere per cassetto



- L. cm 45,5
- L. cm 53,5
- L. cm 61,5
- L. cm 77,5
- L. cm 93,5
- L. cm 109,5
- L. cm 125,5

Ripiani interni



Sp. 2,5 | Sp. 4

- L. 29,5
- L. 45,5
- L. 53,5
- L. 61,5
- L. 77,5
- L. 93,5
- L. 109,5
- L. 125,5
- Per angolare
- Per terminale

Tubi appendiabiti alluminio

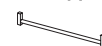

- L. 29,5
- L. 45,5
- L. 53,5
- L. 61,5
- L. 77,5
- L. 93,5
- L. 109,5
- L. 125,5
- Per angolare

B4206	B4106	A406	T4306	S46	FF46
B6206	B6106	A606	T6306	S62	FF62
B9206	B9106	A906	T9306	S95	FF95

ANTA SEGNO

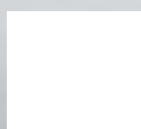

Maniglia incassata a filo H. 31 L. cm 7
H. totale da terra cm 132,1

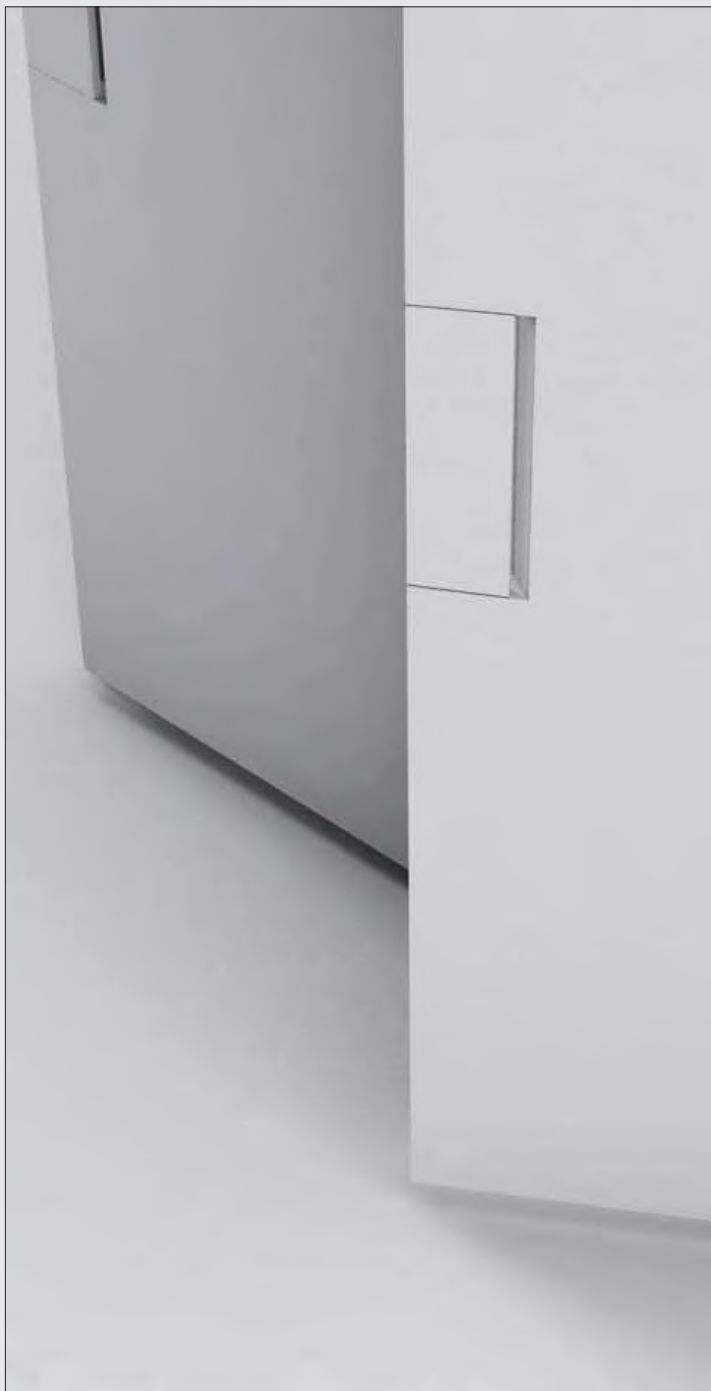

Anta battente SEGNO - Caratteristiche, modularità e finiture

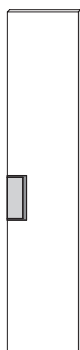

Anta Battente SEGNO

Anta spessore mm 25 in agglomerato superleggero con 6 cerniere per anta con apertura a 110° con chiusura rallentata.
 Nei moduli a due ante è applicato un profilo parapolvere sull'anta di sinistra.
 Maniglia in alluminio e legno presa laterale L. cm 7 H cm 31 incassata sul filo dell'anta con parte in legno realizzata in varie finiture previste a campionario.
 Nelle colonne con doppia anta la maniglia è incassata nella **sola anta destra**.

Finiture previste anta SEGNO

Essenze nostro campionario impiallacciato in verticale
 Laccato opaco

Finiture previste per **personalizzazione maniglia**

Essenze nostro campionario impiallacciate orizzontale
 Laccato opaco colori nostro campionario

LARGHEZZA

- Moduli con struttura P. cm 58,6
- Moduli con struttura P. cm 42,6

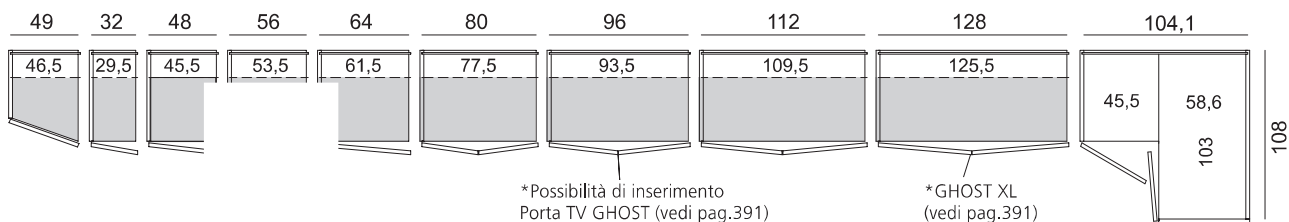

ALTEZZA

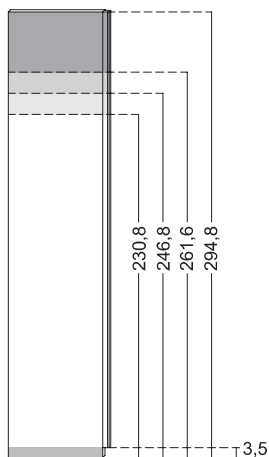

PROFONDITÀ

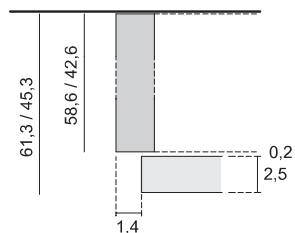

Riduzioni struttura

RIDUZIONE in LARGHEZZA Euro

Il prezzo della riduzione è comprensivo dei tagli:

- Coperchio
- Base
- 1 ripiano
- Schienale

- Anta

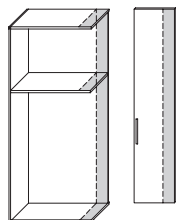

RIDUZIONE in PROFONDITÀ

Il prezzo della riduzione è comprensivo dei tagli e foratura supplementare:

- Coperchio
- Base
- 1 ripiano
- 1 fianco

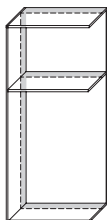

RIDUZIONE in ALTEZZA

Il prezzo della riduzione è comprensivo dei tagli:

- Fianco
- Schienale

- Anta

- Anta con taglio inclinato

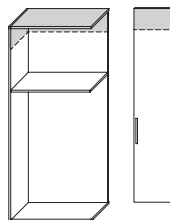

Anta battente SEGNO - Composizioni

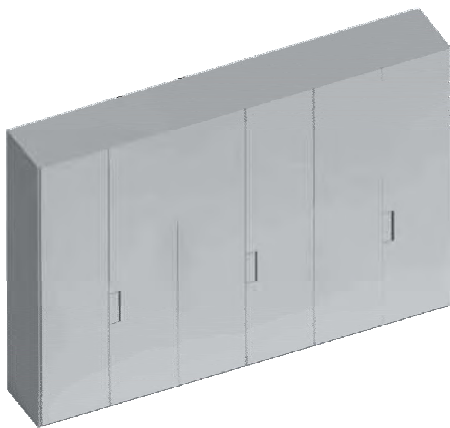

- Armadi P. cm 45,3 stesso prezzo
- Prezzi comprensivi di finitura fianchi come anta
- Incluso un ripiano strutturale Sp. cm 4 a modulo
- Possibilità di inserimento **PORTA TV GHOST** vedi pag.391

3 ANTE

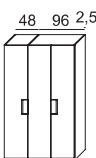
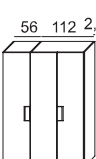
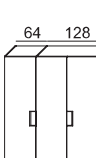
	H.	Codice	Essenza 1	Essenza 2	Laccato Opaco
 L. cm 146,5	230,8	CB3A08			
	246,8	CB4A08			
	261,6	CB6A08			
	294,8	CB9A08			
 L. cm 170,5	230,8	CB3B08			
	246,8	CB4B08			
	261,6	CB6B08			
	294,8	CB9B08			
 L. cm 194,5	230,8	CB3C08			
	246,8	CB4C08			
	261,6	CB6C08			
	294,8	CB9C08			

5 ANTE

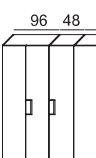
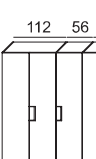
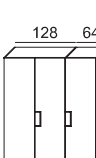
	H.	Codice	Essenza 1	Essenza 2	Laccato Opaco
 L. cm 242,5	230,8	CB3G08			
	246,8	CB4G08			
	261,6	CB6G08			
	294,8	CB9G08			
 L. cm 282,5	230,8	CB3H08			
	246,8	CB4H08			
	261,6	CB6H08			
	294,8	CB9H08			
 L. cm 322,5	230,8	CB3L08			
	246,8	CB4L08			
	261,6	CB6L08			
	294,8	CB9L08			

4 ANTE

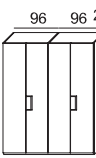
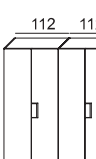
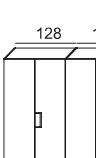
 L. cm 194,5	230,8	CB3D08			
	246,8	CB4D08			
	261,6	CB6D08			
	294,8	CB9D08			
 L. cm 226,5	230,8	CB3E08			
	246,8	CB4E08			
	261,6	CB6E08			
	294,8	CB9E08			
 L. cm 258,5	230,8	CB3F08			
	246,8	CB4F08			
	261,6	CB6F08			
	294,8	CB9F08			

6 ANTE

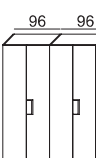
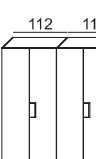
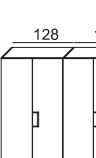
 L. cm 290,5	230,8	CB3M08			
	246,8	CB4M08			
	261,6	CB6M08			
	294,8	CB9M08			
 L. cm 338,5	230,8	CB3N08			
	246,8	CB4N08			
	261,6	CB6N08			
	294,8	CB9N08			
 L. cm 386,5	230,8	CB3P08			
	246,8	CB4P08			
	261,6	CB6P08			
	294,8	CB9P08			

Moduli armadio battente ANTA SEGNO

Il prezzo del modulo comprende:

- 1 fianco struttura Sp. cm 2,5
- 1 ripiano interno Sp. cm 4

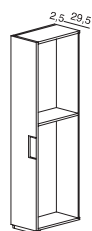

L. cm 32

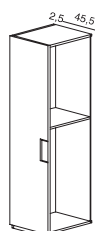

L. cm 48

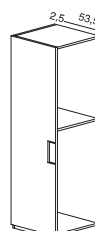

L. cm 56

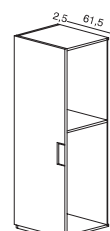

L. cm 64

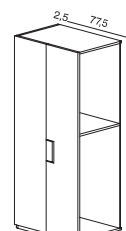

L. cm 80

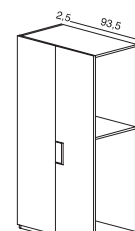

L. cm 96

H. 230,8

Codice

B3308

B3408

B3508

B3608

B3808

B3908

Essenza 1

Essenza 2

Laccato opaco

H. 246,8

B4308

B4408

B4508

B4608

B4808

B4908

Essenza 1

Essenza 2

Laccato opaco

H. 261,6

B6308

B6408

B6508

B6608

B6808

B6908

Essenza 1

Essenza 2

Laccato opaco

H. 294,8

B9308

B9408

B9508

B9608

B9808

B9908

Essenza 1

Essenza 2

Laccato opaco

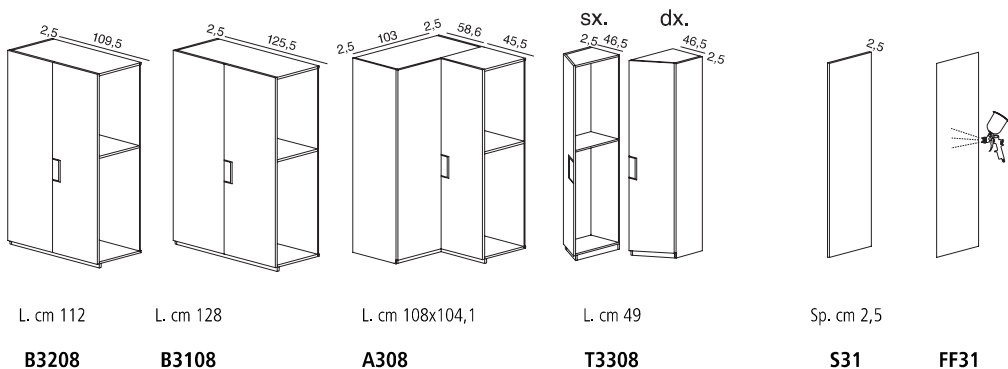

Fianco terminale
in melaminico

Supplemento
finitura fianchi
esterni (cad.)

CASSETTIERE interne 4 cassetti
con guide ammortizzate

Per estrazione totale aggiungere
per cassetto +



- L. cm 45,5
- L. cm 53,5
- L. cm 61,5
- L. cm 77,5
- L. cm 93,5
- L. cm 109,5
- L. cm 125,5

B4208 B4108 A408 T4308 S46 FF46

Ripiani interni



Sp. 2,5 | Sp. 4

- L. 29,5
- L. 45,5
- L. 53,5
- L. 61,5
- L. 77,5
- L. 93,5
- L. 109,5
- L. 125,5
- Per angolare
- Per terminale

B6208 B6108 A608 T6308 S62 FF62

Tubi appendiabiti alluminio



B9208 B9108 A908 T9308 S95 FF95

- L. 29,5
- L. 45,5
- L. 53,5
- L. 61,5
- L. 77,5
- L. 93,5
- L. 109,5
- L. 125,5
- Per angolare

ANTA GROOVE





Maniglia Groove Orizzontale
H. 3,4 L. cm 14,5
H. totale da terra cm 104,8



Maniglia Groove Verticale
H. 14,5 L. cm 3,4
H. totale da terra cm 113,9

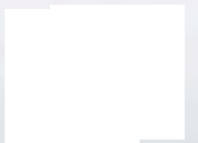

Anta battente GROOVE - Caratteristiche, modularità e finiture

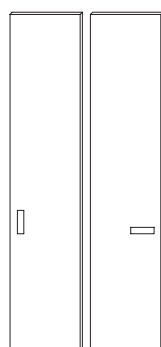

Anta Battente GROOVE

Anta spessore mm 25 in agglomerato superleggero con 6 cerniere per anta con apertura a 110° con chiusura rallentata.
 Nei moduli a due ante è applicato un profilo parapolvere sull'anta di sinistra.
 Maniglia in alluminio e legno incassata a scomparsa con fondello in legno H. cm 15 personalizzabile nelle varie finiture previste a campionario.
 Nelle colonne con doppia anta la maniglia è incassata nella **sola anta destra - posizionamento a scelta in verticale o orizzontale**

Finiture previste anta GROOVE

Essenze nostro campionario impiallacciate in verticale
 Laccato opaco

Finiture previste per **personalizzazione fondello maniglia**

Essenze nostro campionario
 Laccato opaco colori nostro campionario

LARGHEZZA

- Moduli con struttura P. cm 58,6
- Moduli con struttura P. cm 42,6

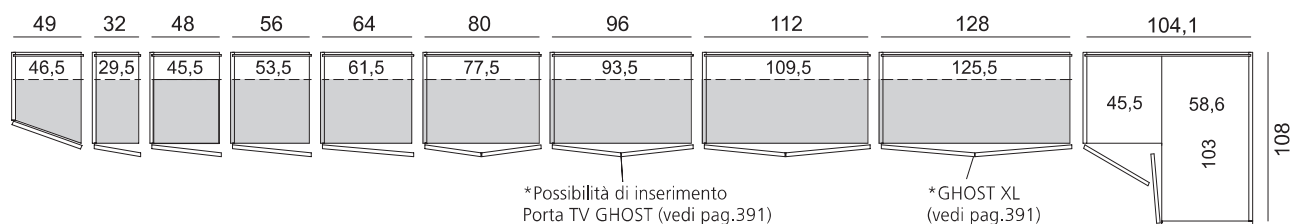

ALTEZZA

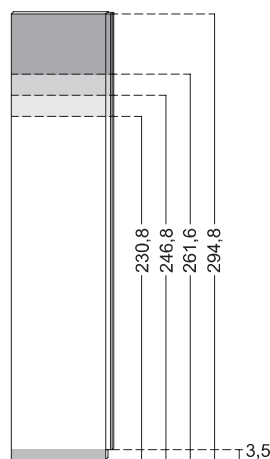

PROFONDITÀ

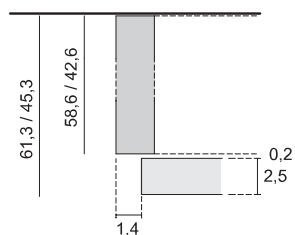

Riduzioni struttura

RIDUZIONE in LARGHEZZA

Il prezzo della riduzione è comprensivo dei tagli:

- Coperchio
- Base
- 1 ripiano
- Schienale

- Anta

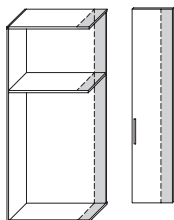

RIDUZIONE in PROFONDITÀ

Il prezzo della riduzione è comprensivo dei tagli e foratura supplementare:

- Coperchio
- Base
- 1 ripiano
- 1 fianco

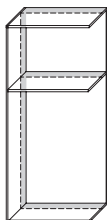

RIDUZIONE in ALTEZZA

Il prezzo della riduzione è comprensivo dei tagli:

- Fianco
- Schienale

- Anta
- Anta con taglio inclinato

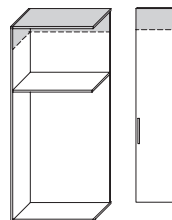

Anta battente GROOVE - Composizioni

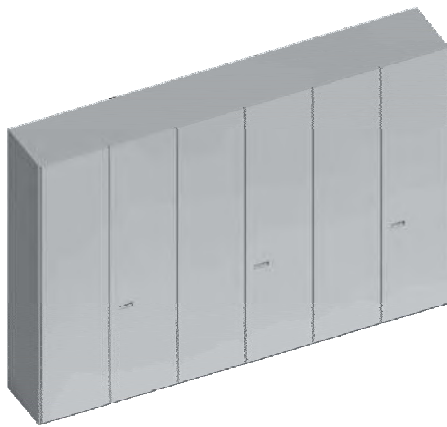

- Armadi P. cm 45,3 stesso prezzo
- Prezzi comprensivi di finitura fianchi come anta
- Escluse maniglie
- Incluso un ripiano strutturale Sp. cm 4 a modulo
- Possibilità di inserimento **PORTA TV GHOST** vedi pag.391

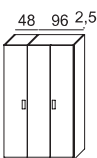
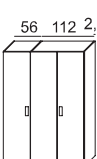
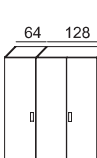

3 ANTE

	H.	Codice	Essenza 1	Essenza 2	Laccato Opaco
 L. cm 146,5	230,8	CB3A09			
	246,8	CB4A09			
	261,6	CB6A09			
	294,8	CB9A09			
 L. cm 170,5	230,8	CB3B09			
	246,8	CB4B09			
	261,6	CB6B09			
	294,8	CB9B09			
 L. cm 194,5	230,8	CB3C09			
	246,8	CB4C09			
	261,6	CB6C09			
	294,8	CB9C09			

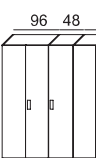
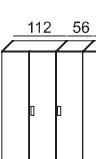
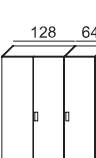
5 ANTE

	H.	Codice	Essenza 1	Essenza 2	Laccato Opaco
 L. cm 242,5	230,8	CB3G09			
	246,8	CB4G09			
	261,6	CB6G09			
	294,8	CB9G09			
 L. cm 282,5	230,8	CB3H09			
	246,8	CB4H09			
	261,6	CB6H09			
	294,8	CB9H09			
 L. cm 322,5	230,8	CB3L09			
	246,8	CB4L09			
	261,6	CB6L09			
	294,8	CB9L09			

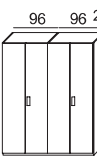
4 ANTE

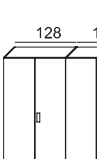
 L. cm 194,5	230,8	CB3D09			
	246,8	CB4D09			
	261,6	CB6D09			
	294,8	CB9D09			
 L. cm 226,5	230,8	CB3E09			
	246,8	CB4E09			
	261,6	CB6E09			
	294,8	CB9E09			
 L. cm 258,5	230,8	CB3F09			
	246,8	CB4F09			
	261,6	CB6F09			
	294,8	CB9F09			

6 ANTE

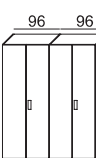
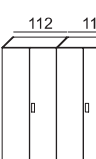
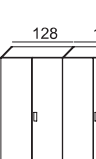
 L. cm 290,5	230,8	CB3M09			
	246,8	CB4M09			
	261,6	CB6M09			
	294,8	CB9M09			
 L. cm 338,5	230,8	CB3N09			
	246,8	CB4N09			
	261,6	CB6N09			
	294,8	CB9N09			
 L. cm 386,5	230,8	CB3P09			
	246,8	CB4P09			
	261,6	CB6P09			
	294,8	CB9P09			

Moduli armadio battente ANTA GROOVE

Il prezzo del modulo comprende:

- 1 fianco struttura Sp. cm 2,5
- 1 ripiano interno Sp. cm 4

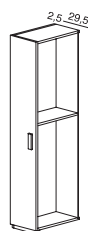

L. cm 32

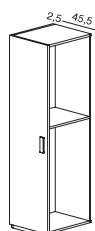

L. cm 48

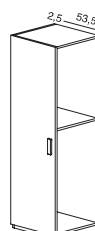

L. cm 56

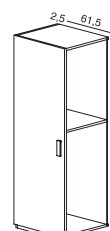

L. cm 64

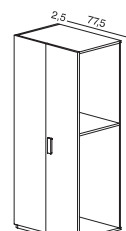

L. cm 80

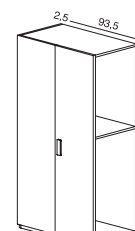

L. cm 96

H. 230,8

Codice

B3309

B3409

B3509

B3609

B3809

B3909

Essenza 1

Essenza 2

Laccato opaco

H. 246,8

B4309

B4409

B4509

B4609

B4809

B4909

Essenza 1

Essenza 2

Laccato opaco

H. 261,6

B6309

B6409

B6509

B6609

B6809

B6909

Essenza 1

Essenza 2

Laccato opaco

H. 294,8

B9309

B9409

B9509

B9609

B9809

B9909

Essenza 1

Essenza 2

Laccato opaco

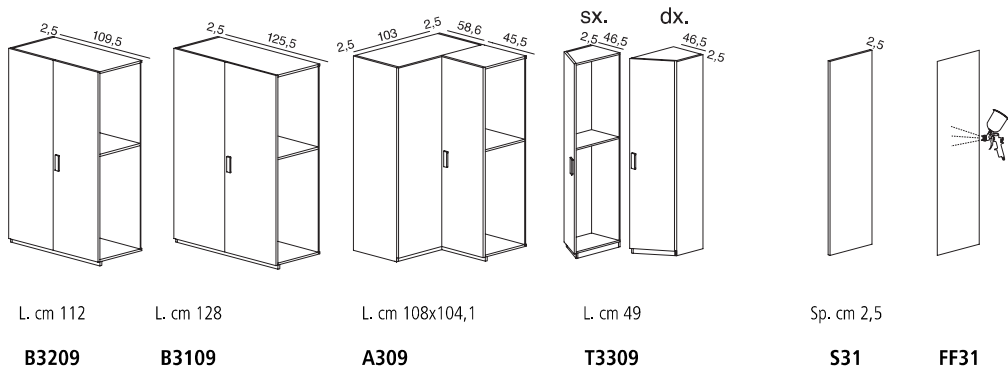

Fianco terminale
in melaminico

Supplemento
finitura fianchi
esterni (cad.)

CASSETTIERE interne 4 cassetti
con guide ammortizzate

Per estrazione totale aggiungere
per cassetto



- L. cm 45,5
- L. cm 53,5
- L. cm 61,5
- L. cm 77,5
- L. cm 93,5
- L. cm 109,5
- L. cm 125,5

B4209 B4109 A409 T4309 S46 FF46

Ripiani interni



Sp. 2,5 | Sp. 4

- L. 29,5
- L. 45,5
- L. 53,5
- L. 61,5
- L. 77,5
- L. 93,5
- L. 109,5
- L. 125,5
- Per angolare
- Per terminale

B6209 B6109 A609 T6309 S62 FF62

Tubi appendiabiti alluminio

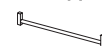

B9209 B9109 A909 T9309 S95 FF95

- L. 29,5
- L. 45,5
- L. 53,5
- L. 61,5
- L. 77,5
- L. 93,5
- L. 109,5
- L. 125,5
- Per angolare

ANTA LINEAR



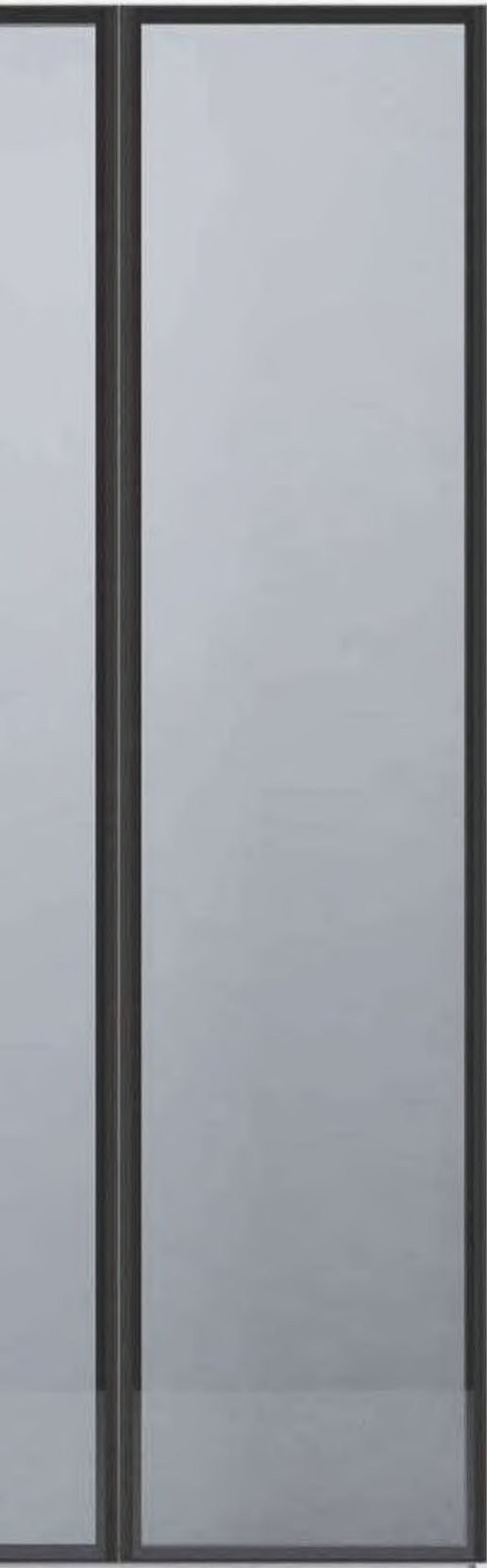

Maniglia tutta altezza integrata al telaio alluminio



Anta battente LINEAR - Caratteristiche, modularità e finiture



Anta Battente LINEAR

Anta spessore mm 35 in alluminio verniciato grigio antracite con inserto in vetro.
L'apertura avviene mediante due cerniere invisibili con chiusura ammortizzata posizionate agli estremi dell'anta.
Apertura tramite fresata laterale sul montante

Finiture previste anta LINEAR

Telaio grigio antracite opaco (di serie)
Telaio con verniciatura personalizzata (colori nostro campionario vedi pag.218)
Vetro trasparente
Vetro grigio

LARGHEZZA

- Moduli con struttura P. cm 58,6
- Moduli con struttura P. cm 42,6

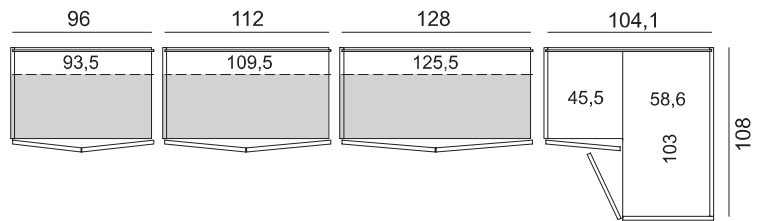
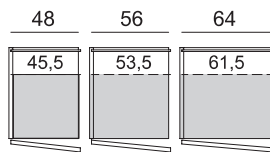

ALTEZZA

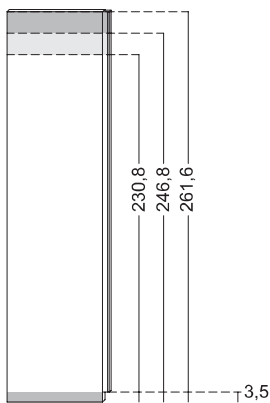

PROFONDITÀ

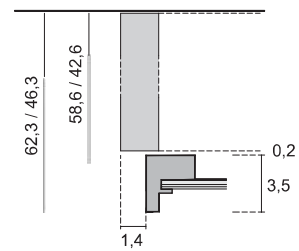

Lavorazione su misura: contattare il nostro Ufficio Tecnico per fattibilità e preventivi

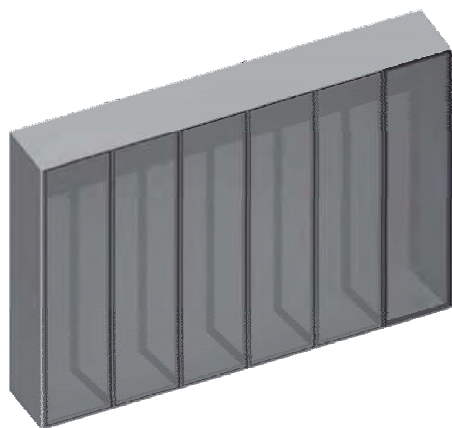



- Armadi P. cm 45,3 stesso prezzo
- Prezzi comprensivi di finitura fianchi laccato opaco
- Incluso un ripiano strutturale Sp. cm 4 a modulo
- Finitura telaio anta Grigio antracite opaco
- Per personalizzazione laccatura telaio vedi pag.218

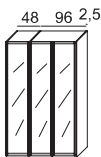
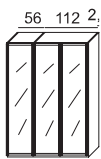
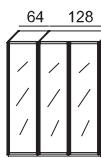

3 ANTE

	H.	Codice	Vetro trasparente	Vetro grigio
 L. cm 146,5	230,8	CB3A10		
	246,8	CB4A10		
	261,6	CB6A10		
 L. cm 170,5	230,8	CB3B10		
	246,8	CB4B10		
	261,6	CB6B10		
 L. cm 194,5	230,8	CB3C10		
	246,8	CB4C10		
	261,6	CB6C10		



5 ANTE

	H.	Codice	Vetro trasparente	Vetro grigio
 L. cm 242,5	230,8	CB3G10		
	246,8	CB4G10		
	261,6	CB6G10		
 L. cm 282,5	230,8	CB3H10		
	246,8	CB4H10		
	261,6	CB6H10		
 L. cm 322,5	230,8	CB3L10		
	246,8	CB4L10		
	261,6	CB6L10		

4 ANTE

 L. cm 194,5	230,8	CB3D10		
	246,8	CB4D10		
	261,6	CB6D10		
 L. cm 226,5	230,8	CB3E10		
	246,8	CB4E10		
	261,6	CB6E10		
 L. cm 258,5	230,8	CB3F10		
	246,8	CB4F10		
	261,6	CB6F10		

6 ANTE

 L. cm 290,5	230,8	CB3M10		
	246,8	CB4M10		
	261,6	CB6M10		
 L. cm 338,5	230,8	CB3N10		
	246,8	CB4N10		
	261,6	CB6N10		
 L. cm 386,5	230,8	CB3P10		
	246,8	CB4P10		
	261,6	CB6P10		

Moduli armadio battente ANTA LINEAR

Il prezzo del modulo comprende:

- 1 fianco struttura Sp. cm 2,5
- 1 ripiano interno Sp. cm 4

Finitura telaio anta:
Grigio antracite opaco

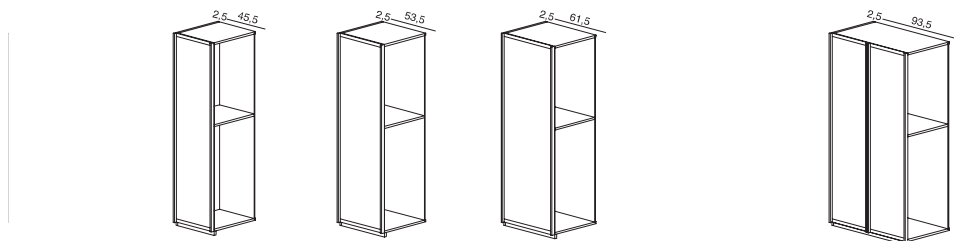

L. cm 48

L. cm 56

L. cm 64

L. cm 96

H. 230,8

Codice

B3410

B3510

B3610

B3910

Vetro trasparente

Vetro grigio

H. 246,8

B4410

B4510

B4610

B4910

Vetro trasparente

Vetro grigio

H. 261,6

B6410

B6510

B6610

B6910

Vetro trasparente

Vetro grigio

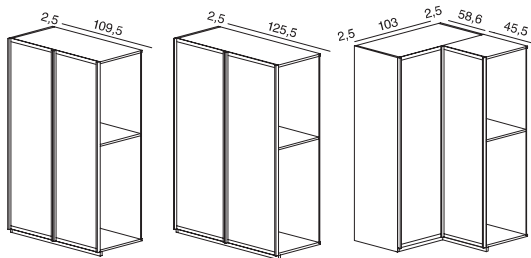

L. cm 112

L. cm 128

L. cm 108x104,1

Fianco terminale
in melaminico



Sp. cm 2,5

Supplemento
finitura fianchi
esterni (cad.)

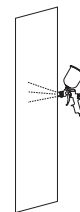

CASSETTIERE interne 4 cassetti
con guide ammortizzate

Per estrazione totale aggiungere
per cassetto + € 30



- L. cm 45,5
- L. cm 53,5
- L. cm 61,5
- L. cm 77,5
- L. cm 93,5
- L. cm 109,5
- L. cm 125,5

Ripiani interni



Sp. 2,5 | Sp. 4

- L. 29,5
- L. 45,5
- L. 53,5
- L. 61,5
- L. 77,5
- L. 93,5
- L. 109,5
- L. 125,5
- Per angolare
- Per terminale

Tubi appendiabiti alluminio

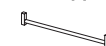

- L. 29,5
- L. 45,5
- L. 53,5
- L. 61,5
- L. 77,5
- L. 93,5
- L. 109,5
- L. 125,5
- Per angolare

B3210	B3110	A310	S31	FF31
				Essenza 1
				Essenza 2
				Laccato opaco
B4210	B4110	A410	S46	FF46
				Essenza 1
				Essenza 2
				Laccato opaco
B6210	B6110	A610	S62	FF62
				Essenza 1
				Essenza 2
				Laccato opaco

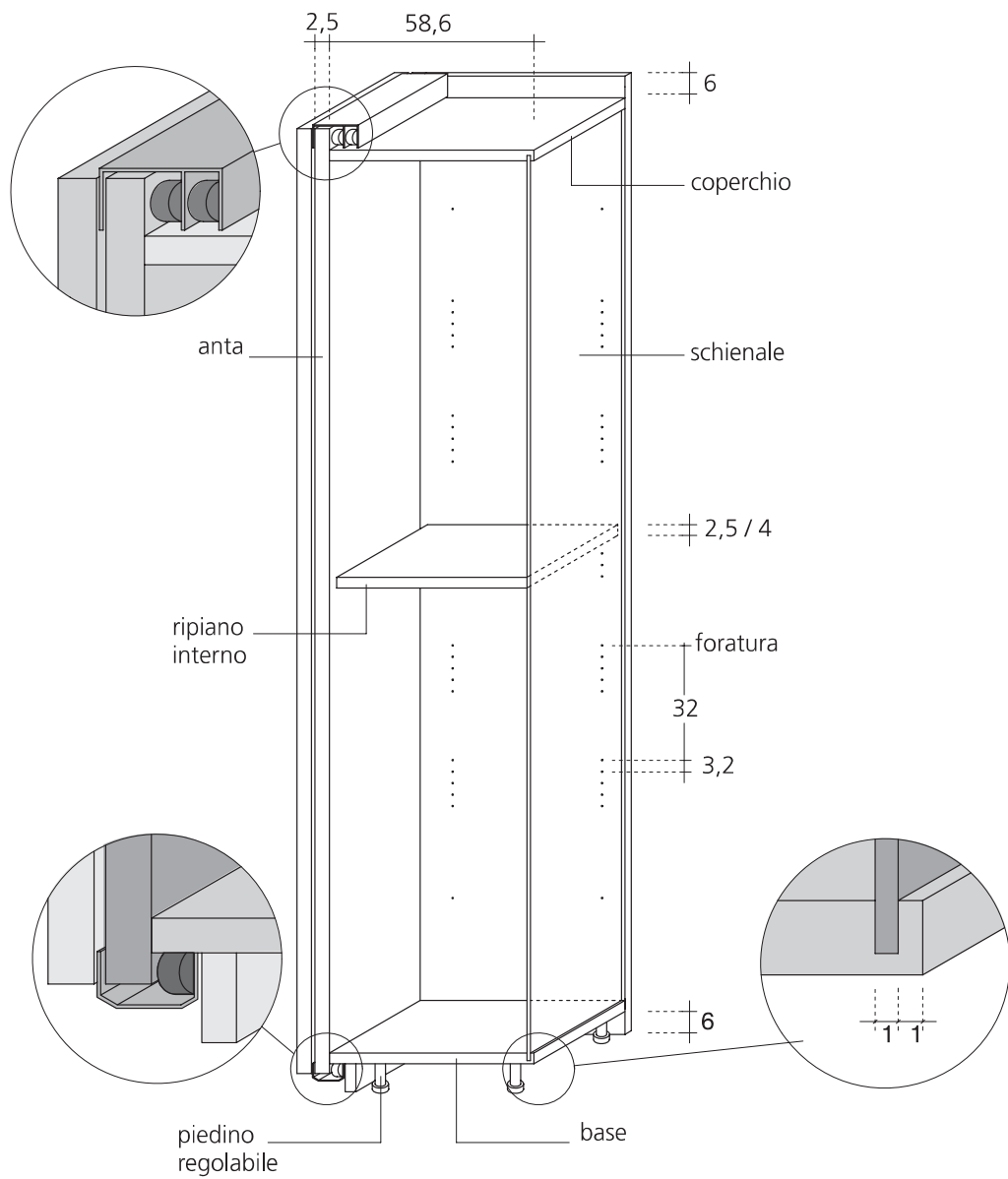

AVVERTENZE:

L'ingombro in altezza dell'armadio è di 15 mm in più dell'altezza del fianco dovuti all'ingombro del meccanismo per lo scorrimento dell'anta esterna.

Per il montaggio dell'armadio scorrevole occorrono 5 cm in più della larghezza dell'armadio e 3 cm in più dell'altezza del fianco.

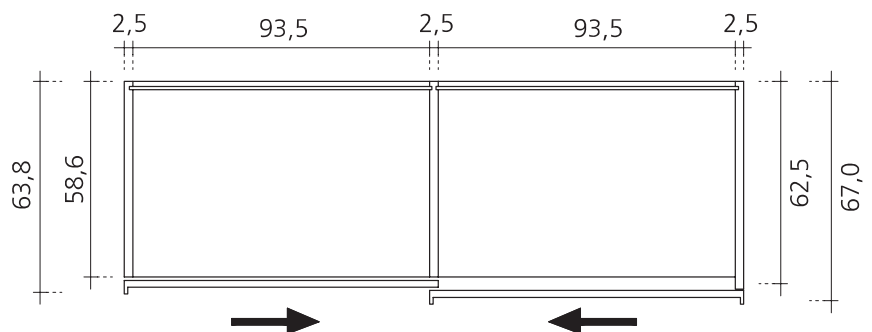

DIMENSIONI

3 altezze

cm 230,8
cm 246,8
cm 261,6

6 larghezze (basamento + fianco)

cm 80
cm 96
cm 112
cm 128
cm 144
cm 160

Profondità

Fianco cm 58,6
Totale con anta cm 63/67

FIANCHI

Spessore mm. 25

Foratura passo 32 cm a grappolo di fori

FIANCHI INTERNI

Finiture: melaminico bianco textura
melaminico grigio textura
melaminico olmo perla
melaminico olmo brown

FIANCHI ESTERNI

Hanno l'interno nelle finiture melaminico e l'esterno personalizzabile nelle essenze o laccature nostro campionario.

COPERCHI E BASI

Spessore mm. 25

Finiture: melaminico bianco textura
melaminico grigio textura
melaminico olmo perla
melaminico olmo brown

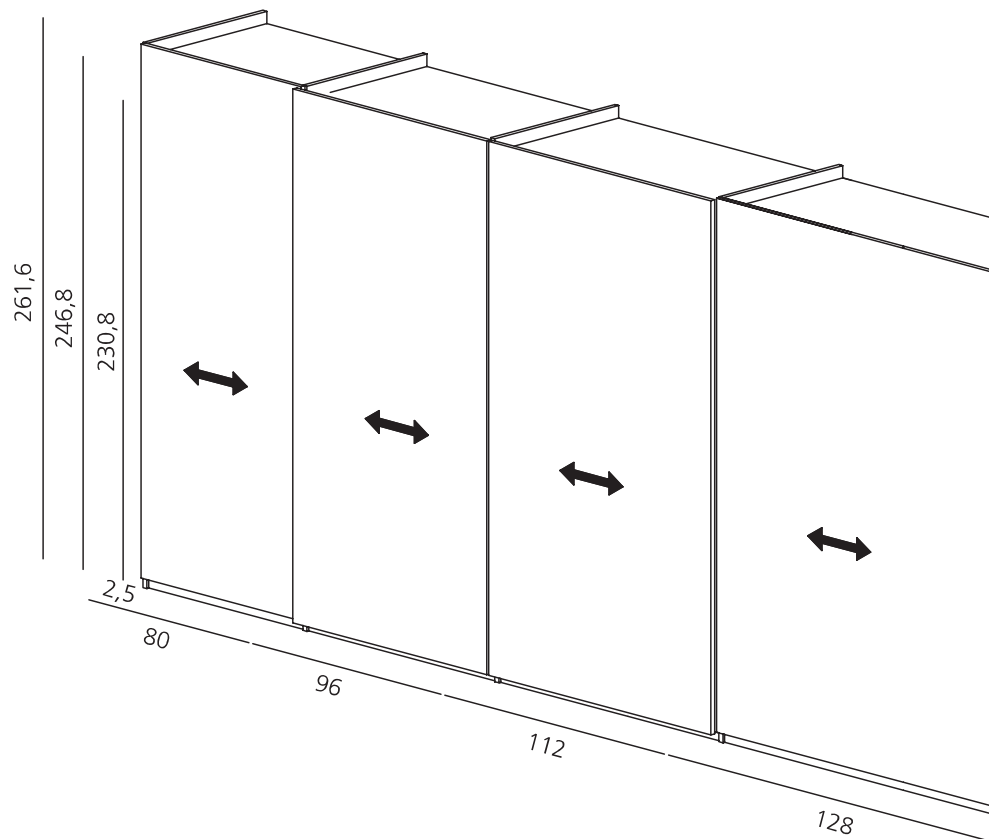

RIPIANI

Spessore mm. 25
Spessore mm. 40

Finiture: melaminico bianco textura
melaminico grigio textura
melaminico olmo perla
melaminico olmo brown
essenze campionario
(solo per spessore mm 40)

SCHIENALI

Spessore mm. 10

Finiture: melaminico bianco textura
melaminico grigio textura
melaminico olmo perla
melaminico olmo brown

TOLLERANZE PER IL MONTAGGIO

in ALTEZZA:
3 cm in più dell'altezza dell'armadio

in LARGHEZZA:
5 cm in più della larghezza dell'armadio

PER ABBINAMENTO MODULI ANTA SCORREVOLE CON MODULI ANTA BATTENTE
INTERPORRE IL FIANCO SUPPLEMENTARE CON SAGOMA DI RACCORDO "A"

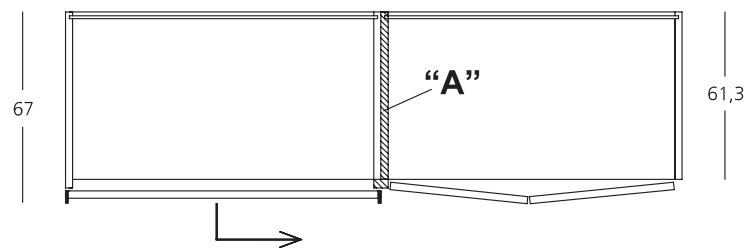

"A" FIANCO SUPPLEMENTARE MELAMINICO CON
SAGOMA DX - SX PER ABBINAMENTO
A MODULI CON ANTA BATTENTE

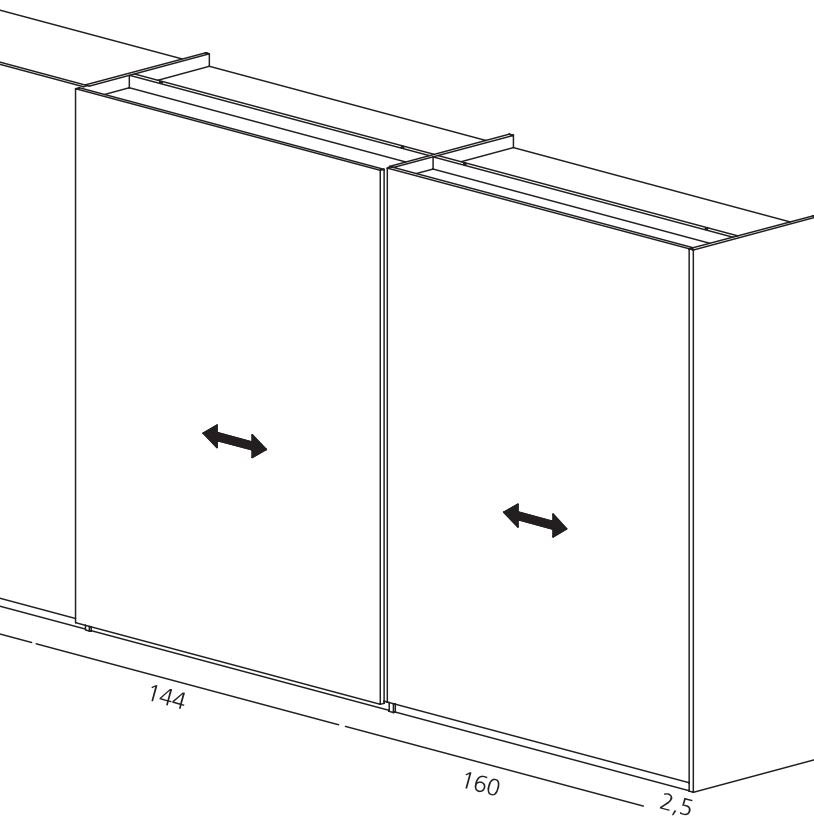
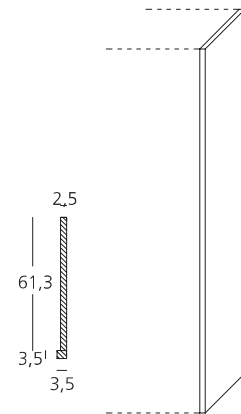

Dimensioni h.	cm 230,8	cm 246,8	cm 261,6
Codice	S31X	S46X	S62X
Sagoma Essenza 1			
Sagoma Essenza 2			
Sagoma Laccato opaco			

MODULI ARMADIO SENZA ANTE - Profondità cm. 58,6

**STRUTTURA MODULI
ARMADIO P. cm 58,6**
(P. cm 42,6 stesso prezzo)

melaminico bianco textura
melaminico grigio textura
melaminico olmo perla
melaminico olmo brown

Compreso 1 fianco struttura
Compreso 1 ripiano interno

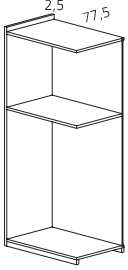
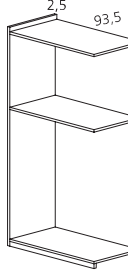
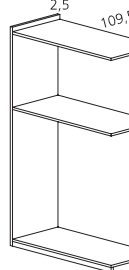
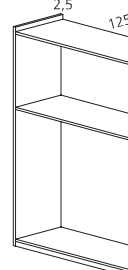
	L. cm 80		L. cm 96		L. cm 112		L. cm 128	
								
H. (in cm)	Codice	Prezzo	Codice	Prezzo	Codice	Prezzo	Codice	Prezzo
230,8	S234		S235		S236L		S236	
246,8	S244		S245		S246L		S246	
261,6	S264		S265		S266L		S266	

**STRUTTURA MODULI
ARMADIO P. cm 58,6**
(P. cm 42,6 stesso prezzo)

melaminico bianco textura
melaminico grigio textura
melaminico olmo perla
melaminico olmo brown

Compreso 1 fianco struttura
Compreso 1 ripiano interno

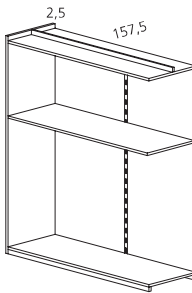
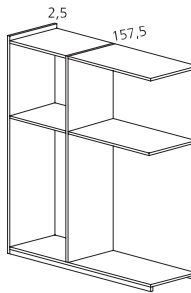
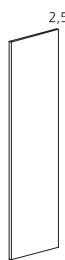
	L. cm 160		L. cm 160		Fianco struttura	
						
H. (in cm.)	Codice	Prezzo	Codice	Prezzo	Codice	Prezzo
230,8	S2311		S2312		S31	
246,8	S2411		S2412		S46	
261,6	S2611		S2612		S62	

L. cm 144

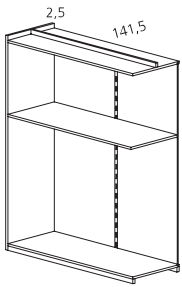

L. cm 144

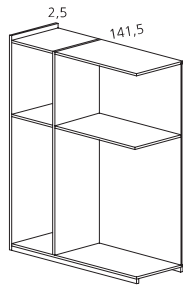

Fianco struttura

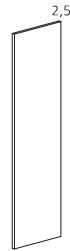

Codice	Prezzo	Codice	Prezzo	Codice	Prezzo
S239		S2310		S31	
S249		S2410		S46	
S269		S2610		S62	

ANTA PIANA





Maniglia in legno sagomata
finiture a campionario
Codice TA104 [redacted]
H. totale da terra cm 118,6



Maniglia in legno sagomata
finiture a campionario
Codice TA18 [redacted]
H. da terra cm 116,4

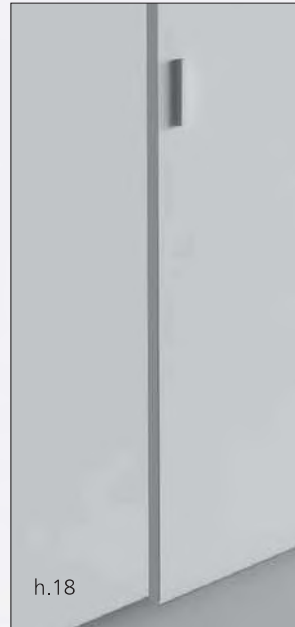

Maniglia in metallo
finitura grigio alluminio
Codice LAP [redacted]
H. totale da terra cm 105,6



Maniglia in metallo
finitura grigio alluminio
Codice MN12 [redacted]
H. totale da terra cm 114,4



Anta scorrevole PIANA - Caratteristiche, modularità e finiture

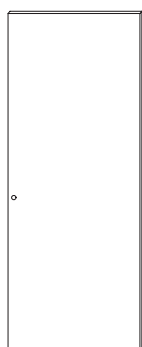

Anta Scorrevole PIANA

Anta spessore mm 25 in agglomerato superleggero con inserti regolatori tendi anta e profilo parapolvere.
Carrelli di scorrimento dotati di fermo ammortizzato in apertura e chiusura.

Finiture previste anta PIANA

Essenze nostro campionario impiallacciato verticale
Laccato opaco
Laccato lucido

Maniglia

Vedi pag.295

LARGHEZZA

- Moduli con struttura P. cm 58,6
- Moduli con struttura P. cm 42,6

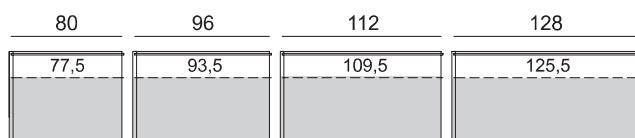

ALTEZZA

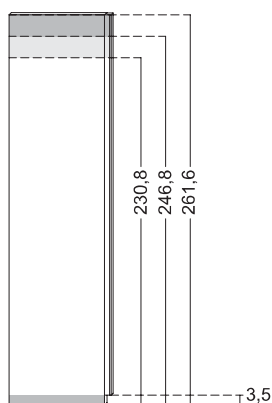

PROFONDITÀ

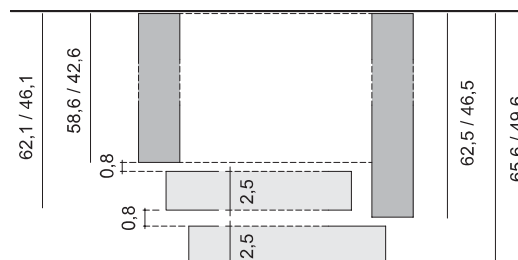

Riduzioni struttura

RIDUZIONE in LARGHEZZA

Il prezzo della riduzione è comprensivo dei tagli:

- Coperchio
- Base
- 1 ripiano
- Schienale

- Anta

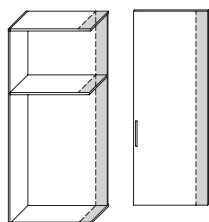

RIDUZIONE in PROFONDITÀ

Il prezzo della riduzione è comprensivo dei tagli e foratura supplementare:

- Coperchio
- Base
- 1 ripiano
- 1 fianco

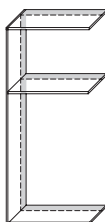

RIDUZIONE in ALTEZZA

Il prezzo della riduzione è comprensivo dei tagli:

- Fianco
- Schienale

- Anta

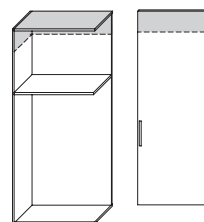

Anta scorrevole PIANA - Composizioni

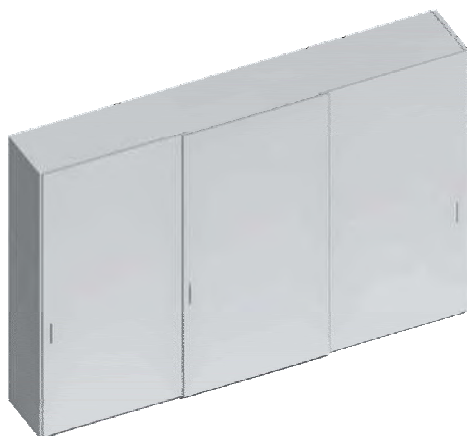

- Armadi P. cm 42,6 stesso prezzo
- Prezzi comprensivi di finitura fianchi come anta
- Prezzi escluse maniglie vedi pag.295
- Incluso un ripiano strutturale Sp. cm 4 a modulo

2 ANTE

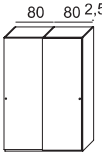
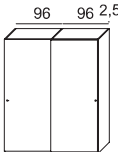
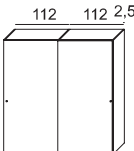
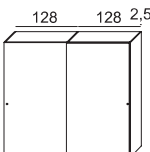
	H.	Codice	Essenza 1	Essenza 2	Laccato Opaco
 L. cm 162,5	230,8	CS3A01			
	246,8	CS4A01			
	261,6	CS6A01			
 L. cm 194,5	230,8	CS3B01			
	246,8	CS4B01			
	261,6	CS6B01			
 L. cm 226,5	230,8	CS3C01			
	246,8	CS4C01			
	261,6	CS6C01			
 L. cm 258,5	230,8	CS3D01			
	246,8	CS4D01			
	261,6	CS6D01			

3 ANTE

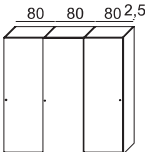
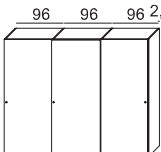
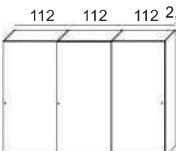
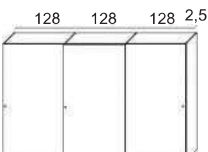
	H.	Codice	Essenza 1	Essenza 2	Laccato Opaco
 L. cm 242,5	230,8	CS3G01			
	246,8	CS4G01			
	261,6	CS6G01			
 L. cm 290,5	230,8	CS3H01			
	246,8	CS4H01			
	261,6	CS6H01			
 L. cm 338,5	230,8	CS3L01			
	246,8	CS4L01			
	261,6	CS6L01			
 L. cm 386,5	230,8	CS3M01			
	246,8	CS4M01			
	261,6	CS6M01			

Moduli armadio anta scorrevole PIANA

Il prezzo del modulo comprende:

- 1 fianco struttura Sp. cm 2,5
- 1 ripiano interno Sp. cm 4

Escluse maniglie

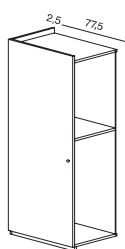

L. cm 80

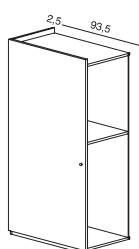

L. cm 96

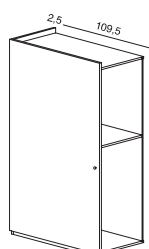

L. cm 112

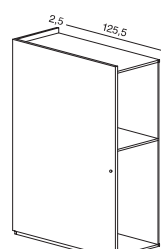

L. cm 128

H. 230,8	Codice	S3801	S3901	S3201	S3101
Essenza 1					
Essenza 2					
Laccato opaco					
Laccato lucido					

H. 246,8	S4801	S4901	S4201	S4101
Essenza 1				
Essenza 2				
Laccato opaco				
Laccato lucido				

H. 261,6	S6801	S6901	S6201	S6101
Essenza 1				
Essenza 2				
Laccato opaco				
Laccato lucido				

Fianco terminale
in melaminico

Supplemento
finitura fianchi
esterni (cad.)

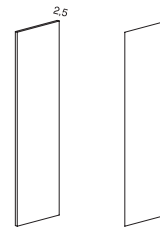

Sp. cm 2,5

CASSETTIERE interne 4 cassetti
con guide ammortizzate

Per estrazione totale aggiungere
per cassetto



S31

FF31

- L. cm 77,5
- L. cm 93,5
- L. cm 109,5
- L. cm 125,5

S46

FF46

Ripiani interni



Sp. 2,5 | Sp. 4

- L. 77,5
- L. 93,5
- L. 109,5
- L. 125,5

S62

FF62

Tubi appendiabiti alluminio



- L. 77,5
- L. 93,5
- L. 109,5
- L. 125,5

ANTA PROFILO ORIZZONTE

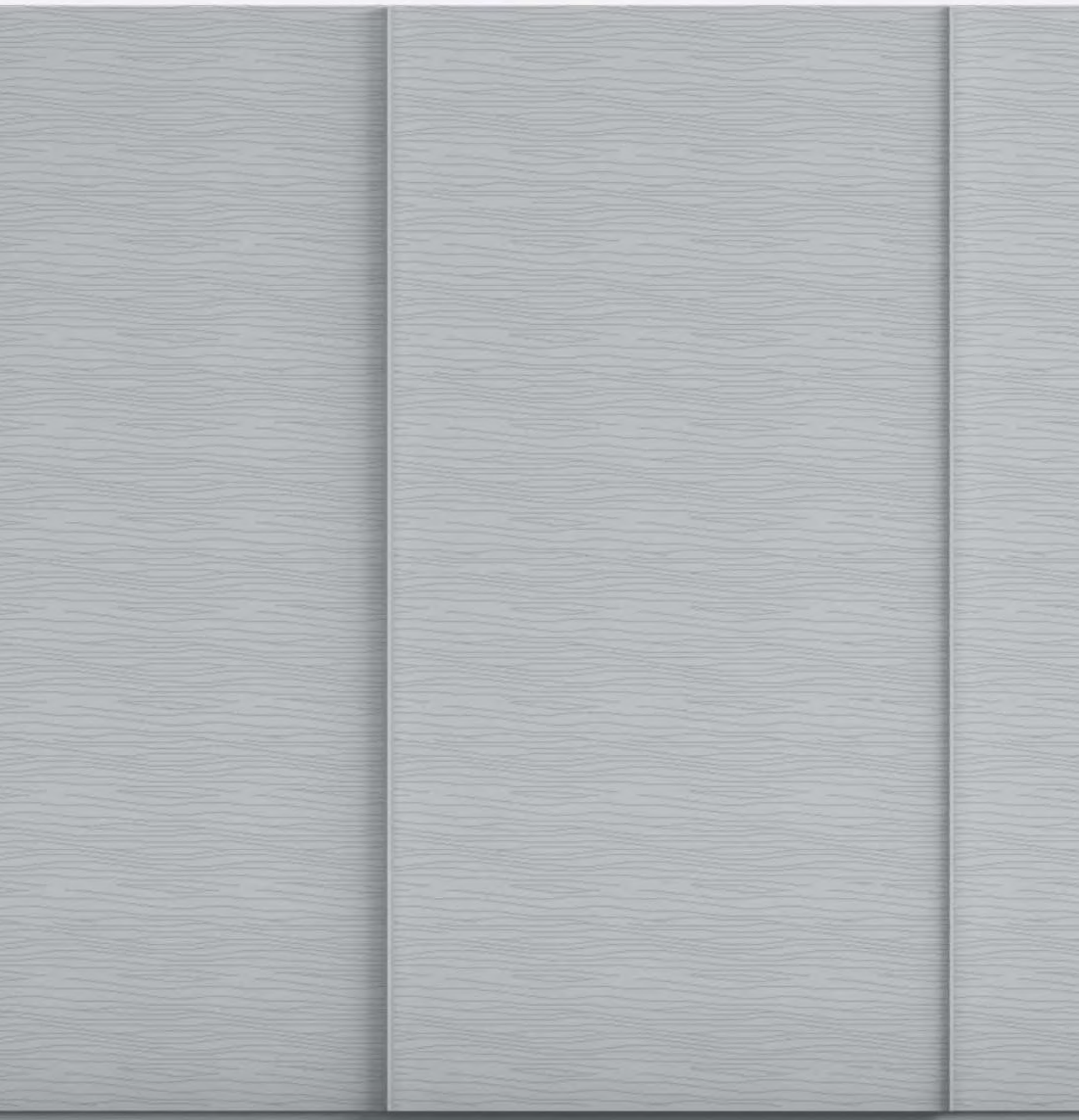

Maniglia profilo verticale a tutta altezza



Anta scorrevole PROFILO ORIZZONTE - Caratteristiche, modularità e finiture

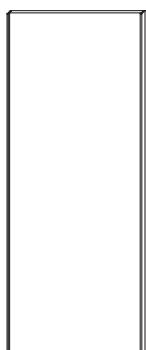

Anta Scorrevole
PROFILO ORIZZONTE

Anta spessore mm 25 in agglomerato superleggero con profilo maniglia verticale L, mm 6 - regolatori tendi anta e profilo parapolvere. Carrelli di scorrimento dotati di fermo ammortizzato in apertura e chiusura.

Finiture previste anta
PROFILO ORIZZONTE

Essenze nostro campionario impiallacciato orizzontale
Laccato opaco
Laccato lucido

Finiture previste maniglia

Tutte le Essenze ad esclusione della Quercia
Laccato opaco

- Moduli con struttura P. cm 58,6
- Moduli con struttura P. cm 42,6

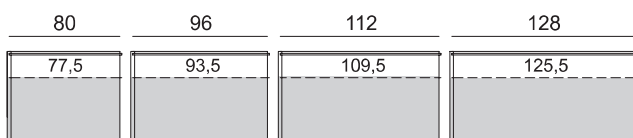

ALTEZZA

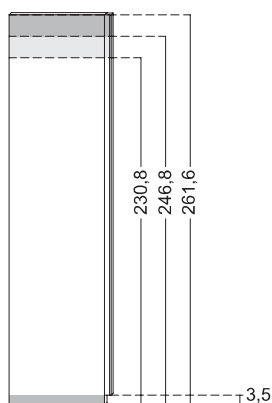

PROFONDITÀ

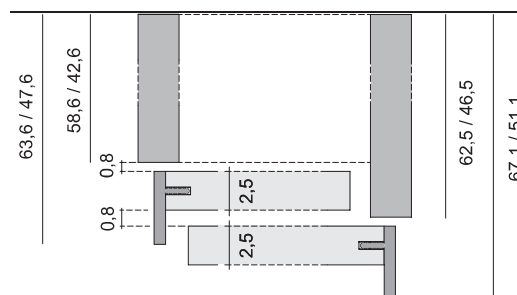

Riduzioni struttura

RIDUZIONE in LARGHEZZA

Il prezzo della riduzione è comprensivo dei tagli:

- Coperchio
- Base
- 1 ripiano
- Schienale

- Anta

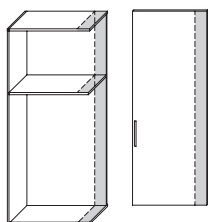

RIDUZIONE in PROFONDITÀ

Il prezzo della riduzione è comprensivo dei tagli e foratura supplementare:

- Coperchio
- Base
- 1 ripiano
- 1 fianco

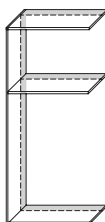

RIDUZIONE in ALTEZZA

Il prezzo della riduzione è comprensivo dei tagli:

- Fianco
- Schienale

- Anta

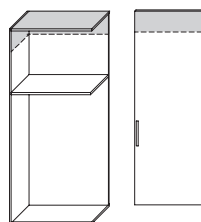

Anta scorrevole PROFILO ORIZZONTE - Composizioni

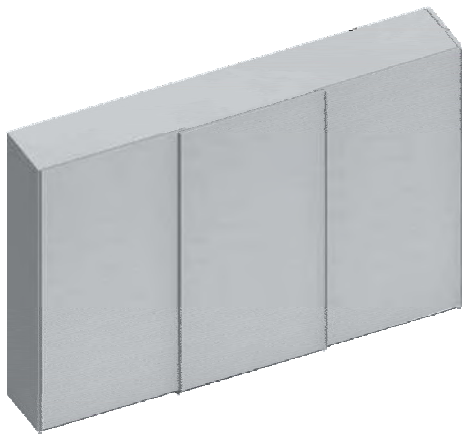

- Armadi P. cm 42,6 stesso prezzo
- Prezzi comprensivi di finitura fianchi come anta
- Incluso un ripiano strutturale Sp. cm 4 a modulo

2 ANTE

	H.	Codice	Essenza 1	Essenza 2
<p>L. cm 162,5</p>	230,8	CS3A02		
	246,8	CS4A02		
	261,6	CS6A02		
<p>L. cm 194,5</p>	230,8	CS3B02		
	246,8	CS4B02		
	261,6	CS6B02		
<p>L. cm 226,5</p>	230,8	CS3C02		
	246,8	CS4C02		
	261,6	CS6C02		
<p>L. cm 258,5</p>	230,8	CS3D02		
	246,8	CS4D02		
	261,6	CS6D02		

3 ANTE

	H.	Codice	Essenza 1	Essenza 2
<p>L. cm 242,5</p>	230,8	CS3G02		
	246,8	CS4G02		
	261,6	CS6G02		
<p>L. cm 290,5</p>	230,8	CS3H02		
	246,8	CS4H02		
	261,6	CS6H02		
<p>L. cm 338,5</p>	230,8	CS3L02		
	246,8	CS4L02		
	261,6	CS6L02		
<p>L. cm 386,5</p>	230,8	CS3M02		
	246,8	CS4M02		
	261,6	CS6M02		

Moduli armadio anta scorrevole PROFILO ORIZZONTE

Il prezzo del modulo comprende:

- 1 fianco struttura Sp. cm 2,5
- 1 ripiano interno Sp. cm 4

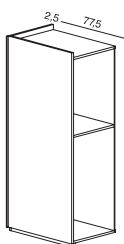

L. cm 80

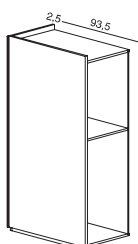

L. cm 96

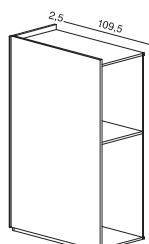

L. cm 112

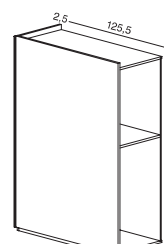

L. cm 128

H. 230,8	Codice	S3802	S3902	S3202	S3102
Essenza 1					
Essenza 2					

H. 246,8	S4802	S4902	S4202	S4102
Essenza 1				
Essenza 2				

H. 261,6	S6802	S6902	S6202	S6102
Essenza 1				
Essenza 2				

Fianco terminale
in melaminico

Supplemento
finitura fianchi
esterni (cad.)

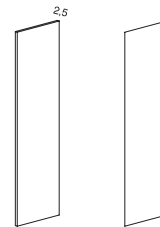

Sp. cm 2,5

S31

FF31

CASSETTIERE interne 4 cassetti
con guide ammortizzate

Per estrazione totale aggiungere
per cassetto + € 30



- L. cm 77,5
- L. cm 93,5
- L. cm 109,5
- L. cm 125,5

S46

FF46

Ripiani interni



Sp. 2,5 | Sp. 4

- L. 77,5
- L. 93,5
- L. 109,5
- L. 125,5

S62

FF62

Tubi appendiabiti alluminio



- L. 77,5
- L. 93,5
- L. 109,5
- L. 125,5

ANTA PROFILO VERTICALE



Maniglia profilo verticale a tutta altezza



Anta scorrevole PROFILO VERTICALE - Caratteristiche, modularità e finiture

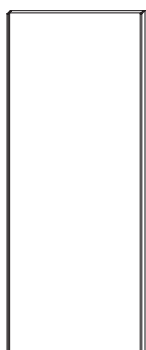

Anta Scorrevole
PROFILO VERTICALE

Anta spessore mm 25 in agglomerato superleggero con profilo maniglia verticale L, mm 6 - regolatori tendi anta e profilo parapolvere. Carrelli di scorrimento dotati di fermo ammortizzato in apertura e chiusura.

Finiture previste anta
PROFILO VERTICALE

Essenze nostro campionario impiallacciato verticale
Laccato opaco

Finiture previste maniglia

Tutte le Essenze ad esclusione della Quercia
Laccato opaco

- Moduli con struttura P. cm 58,6
- Moduli con struttura P. cm 42,6

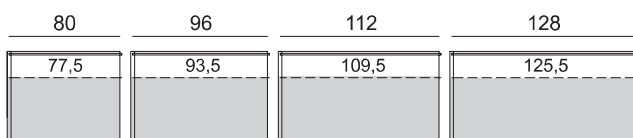

ALTEZZA

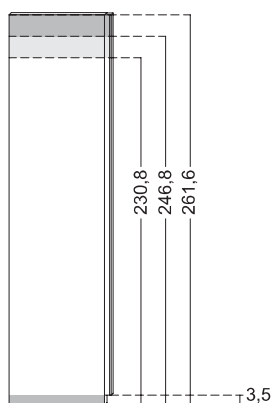

PROFONDITÀ

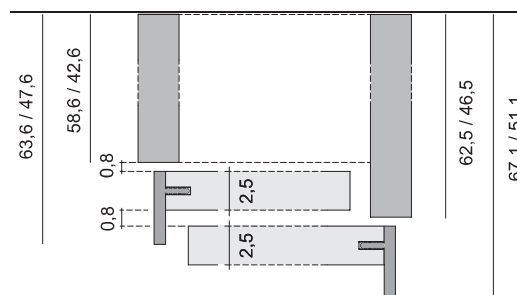

Riduzioni struttura

RIDUZIONE in LARGHEZZA

Il prezzo della riduzione è comprensivo dei tagli:

- Coperchio
- Base
- 1 ripiano
- Schienale

- Anta

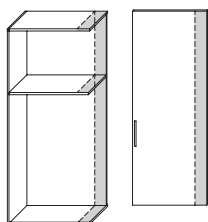

RIDUZIONE in PROFONDITÀ

Il prezzo della riduzione è comprensivo dei tagli e foratura supplementare:

- Coperchio
- Base
- 1 ripiano
- 1 fianco

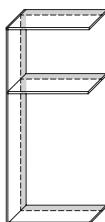

RIDUZIONE in ALTEZZA

Il prezzo della riduzione è comprensivo dei tagli:

- Fianco
- Schienale

- Anta

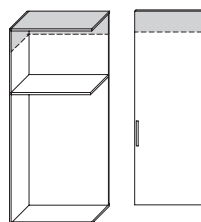

Anta scorrevole PROFILO VERTICALE - Composizioni

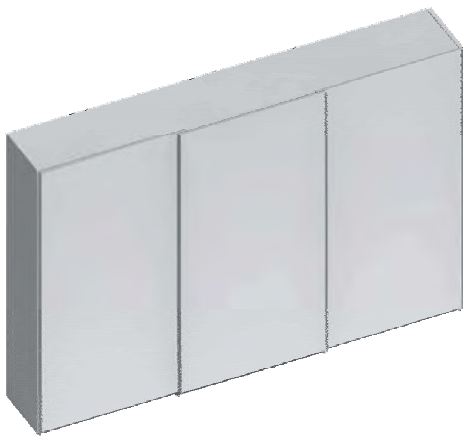

- Armadi P. cm 42,6 stesso prezzo
- Prezzi comprensivi di finitura fianchi come anta
- Incluso un ripiano strutturale Sp. cm 4 a modulo

2 ANTE

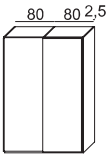
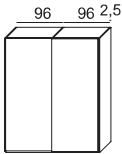
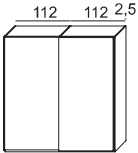
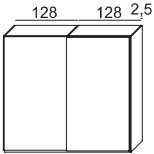
	H.	Codice	Essenza 1	Essenza 2	Laccato Opaco
 <p>L. cm 162,5</p>	230,8	CS3A03			
	246,8	CS4A03			
	261,6	CS6A03			
 <p>L. cm 194,5</p>	230,8	CS3B03			
	246,8	CS4B03			
	261,6	CS6B03			
 <p>L. cm 226,5</p>	230,8	CS3C03			
	246,8	CS4C03			
	261,6	CS6C03			
 <p>L. cm 258,5</p>	230,8	CS3D03			
	246,8	CS4D03			
	261,6	CS6D03			

3 ANTE

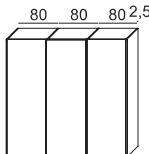
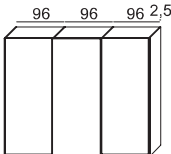
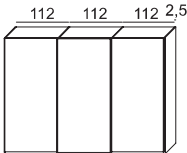
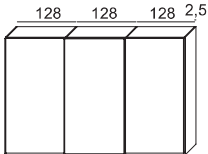
	H.	Codice	Essenza 1	Essenza 2	Laccato Opaco
 <p>L. cm 242,5</p>	230,8	CS3G03			
	246,8	CS4G03			
	261,6	CS6G03			
 <p>L. cm 290,5</p>	230,8	CS3H03			
	246,8	CS4H03			
	261,6	CS6H03			
 <p>L. cm 338,5</p>	230,8	CS3L03			
	246,8	CS4L03			
	261,6	CS6L03			
 <p>L. cm 386,5</p>	230,8	CS3M03			
	246,8	CS4M03			
	261,6	CS6M03			

Moduli armadio anta scorrevole PROFILO VERTICALE

**Il prezzo del modulo
comprende:**

- 1 fianco struttura Sp. cm 2,5
- 1 ripiano interno Sp. cm 4

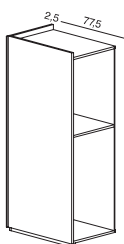

L. cm 80

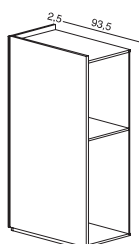

L. cm 96

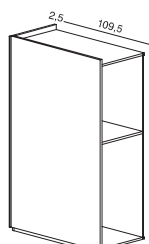

L. cm 112

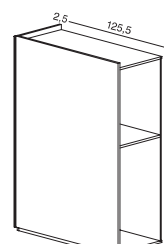

L. cm 128

H. 230,8	Codice	S3803	S3903	S3203	S3103
Essenza 1					
Essenza 2					
Laccato opaco					

H. 246,8	S4803	S4903	S4203	S4103
Essenza 1				
Essenza 2				
Laccato opaco				

H. 261,6	S6803	S6903	S6203	S6103
Essenza 1				
Essenza 2				
Laccato opaco				

Fianco terminale
in melaminico

Supplemento
finitura fianchi
esterni (cad.)

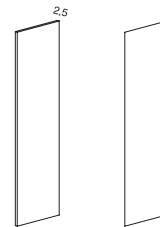

Sp. cm 2,5

S31

FF31

CASSETTIERE interne 4 cassetti
con guide ammortizzate

Per estrazione totale aggiungere
per cassetto



- L. cm 77,5
- L. cm 93,5
- L. cm 109,5
- L. cm 125,5

S46

FF46

Ripiani interni



Sp. 2,5 | Sp. 4

- L. 77,5
- L. 93,5
- L. 109,5
- L. 125,5

S62

FF62

Tubi appendiabiti alluminio



- L. 77,5
- L. 93,5
- L. 109,5
- L. 125,5

ANTA SEGNO



Maniglia incassata a filo L. cm 7



Anta scorrevole SEGNO - Caratteristiche, modularità e finiture

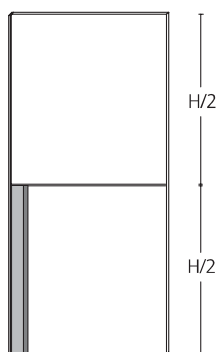

Anta Scorrevole SEGNO

Anta spessore mm 25 in agglomerato superleggero divisa in due settori con profilo maniglia a filo con presa laterale - regolatori tendi anta e profilo parapolvere. Insetti in vetro o in essenza incassati a filo.

Carrelli di scorrimento dotati di fermo ammortizzato in apertura e chiusura.

N.B.: l'anta viene consegnata assemblata salvo diverse indicazioni in fase d'ordine.

Finiture previste anta SEGNO

Essenze nostro campionario impiallacciato in orizzontale

Laccato opaco

Inserto maniglia laccato o essenze a campionario.

LARGHEZZA

□ Moduli con struttura P. cm 58,6

■ Moduli con struttura P. cm 42,6

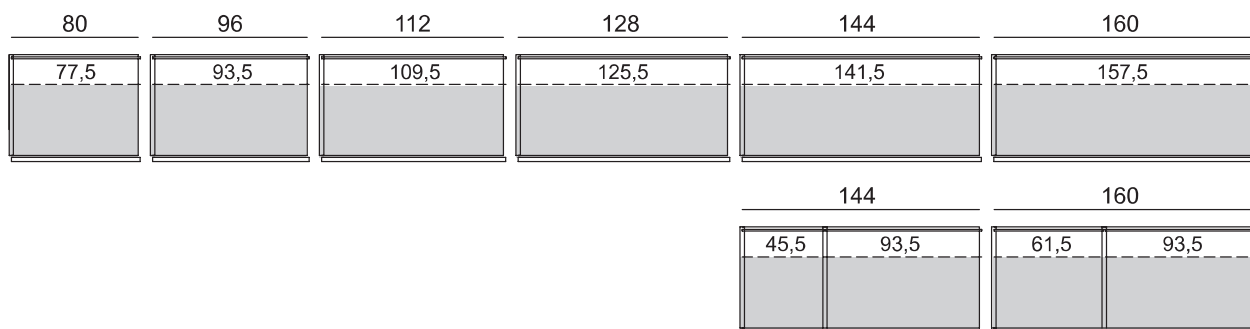

ALTEZZA

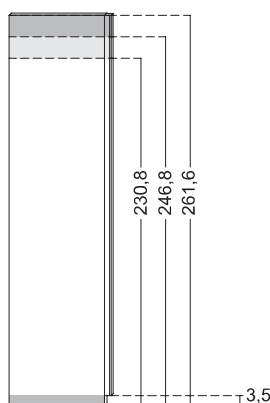

PROFONDITÀ

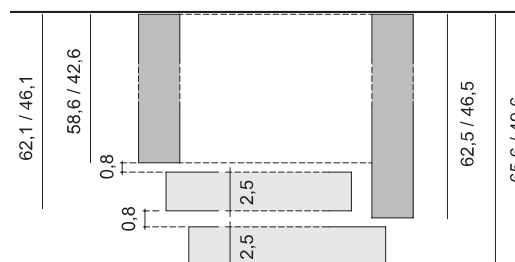

Riduzioni struttura

RIDUZIONE in LARGHEZZA

Il prezzo della riduzione è comprensivo dei tagli:

- Coperchio
- Base
- 1 ripiano
- Schienale

- Anta

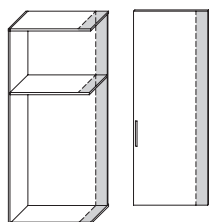

RIDUZIONE in PROFONDITÀ

Il prezzo della riduzione è comprensivo dei tagli e foratura supplementare:

- Coperchio
- Base
- 1 ripiano
- 1 fianco

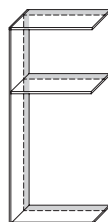

RIDUZIONE in ALTEZZA

Il prezzo della riduzione è comprensivo dei tagli:

- Fianco
- Schienale

- Anta

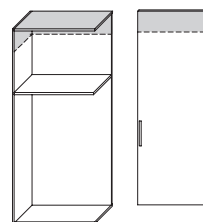





Anta scorrevole SEGNO - Composizioni





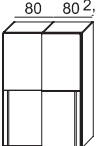
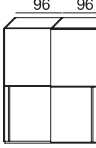

- Armadi P. cm 42,6 stesso prezzo
- Prezzi comprensivi di finitura fianchi come anta
- Incluso un ripiano strutturale Sp. cm 4 a modulo

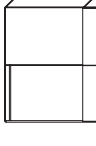
- Il prezzo si riferisce alle ante
 Gli inserti sono disponibili in tutte le nostre finiture (escluso laccato lucido) senza differenza di prezzo.

2 ANTE

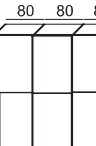
	H.	Codice	Essenza 1	Essenza 2	Laccato Opaco
 L. cm 162,5	230,8	CS3A04			
	246,8	CS4A04			
	261,6	CS6A04			
 L. cm 194,5	230,8	CS3B04			
	246,8	CS4B04			
	261,6	CS6B04			
 L. cm 226,5	230,8	CS3C04			
	246,8	CS4C04			
	261,6	CS6C04			
 L. cm 258,5	230,8	CS3D04			
	246,8	CS4D04			
	261,6	CS6D04			
 L. cm 290,5	230,8	CS3E04			
	246,8	CS4E04			
	261,6	CS6E04			
 L. cm 322,5	230,8	CS3F04			
	246,8	CS4F04			
	261,6	CS6F04			

3 ANTE

	H.	Codice	Essenza 1	Essenza 2	Laccato Opaco
 L. cm 242,5	230,8	CS3G04			
	246,8	CS4G04			
	261,6	CS6G04			
 L. cm 290,5	230,8	CS3H04			
	246,8	CS4H04			
	261,6	CS6H04			
 L. cm 338,5	230,8	CS3L04			
	246,8	CS4L04			
	261,6	CS6L04			
 L. cm 386,5	230,8	CS3M04			
	246,8	CS4M04			
	261,6	CS6M04			

**Il prezzo del modulo
comprende:**

- 1 fianco struttura Sp. cm 2,5
- 1 ripiano interno Sp. cm 4

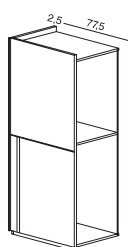

L. cm 80

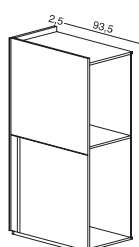

L. cm 96

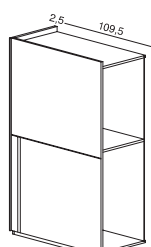

L. cm 112

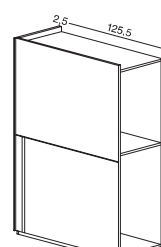

L. cm 128

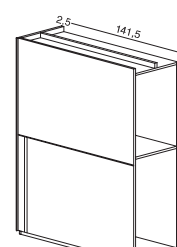

L. cm 144

H. 230,8	Codice	S3804	S3904	S3204	S3104	S3144C
Essenza 1						
Essenza 2						
Laccato opaco						

H. 246,8		S4804	S4904	S4204	S4104	S4144C
Essenza 1						
Essenza 2						
Laccato opaco						

H. 261,6		S6804	S6904	S6204	S6104	S6144C
Essenza 1						
Essenza 2						
Laccato opaco						

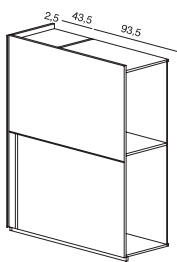

L. cm 144

S3144

2.115

1.993

1.930

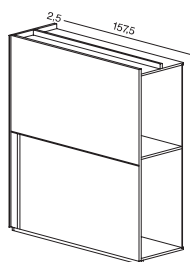

L. cm 160

S3164C

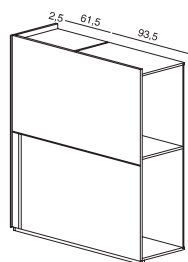

L. cm 160

S3164

Fianco terminale
in melaminico

Supplemento
finitura fianchi
esterni (cad.)

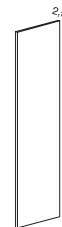

Sp. cm 2,5

S31



FF31

CASSETTIERE interne 4 cassetti
con guide ammortizzate

Per estrazione totale aggiungere
per cassetto + € 30



- L. cm 45,5
- L. cm 61,5
- L. cm 77,5
- L. cm 93,5
- L. cm 109,5
- L. cm 125,5

S4144

S4164C

S4164

S46

FF46

2.115

1.993

1.930

Ripiani interni



Sp. 2,5 | Sp. 4

- L. 45,5
- L. 61,5
- L. 77,5
- L. 93,5
- L. 109,5
- L. 125,5
- L. 141,5
- L. 157,5

S6144

S6164C

S6164

S62

FF62

2.115

1.993

1.930

Tubi appendiabiti alluminio



- L. 45,5
- L. 61,5
- L. 77,5
- L. 93,5
- L. 109,5
- L. 125,5
- L. 141,5
- L. 157,5

ANTA STRIP

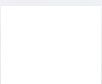

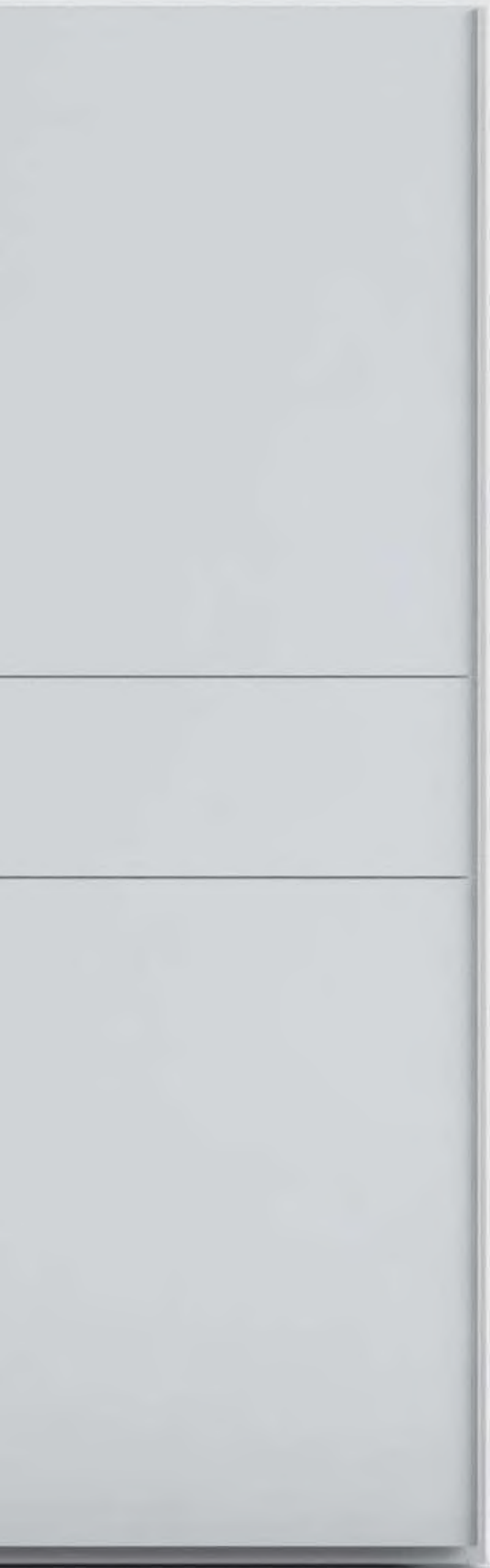

Maniglia profilo verticale a tutta altezza



Anta scorrevole STRIP - Caratteristiche, modularità e finiture

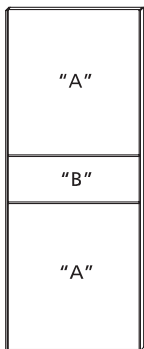

Anta Scorrevole STRIP

Anta spessore mm 25 in agglomerato superleggero con profilo maniglia verticale L, mm 6 - regolatori tendi anta e profilo parapolvere.
Carrelli di scorrimento dotati di fermo ammortizzato in apertura e chiusura.
N.B.: l'anta viene consegnata assemblata salvo diverse indicazioni in fase d'ordine.

Finiture previste anta STRIP

Essenze nostro campionario impiallacciato orizzontale
Laccato opaco

Finiture previste maniglia

Tutte le Essenze ad esclusione della Quercia
Laccato opaco

LARGHEZZA

- Moduli con struttura P. cm 58,6
- Moduli con struttura P. cm 42,6

* Possibilità di inserimento
Porta TV GHOST (vedi pag.392)

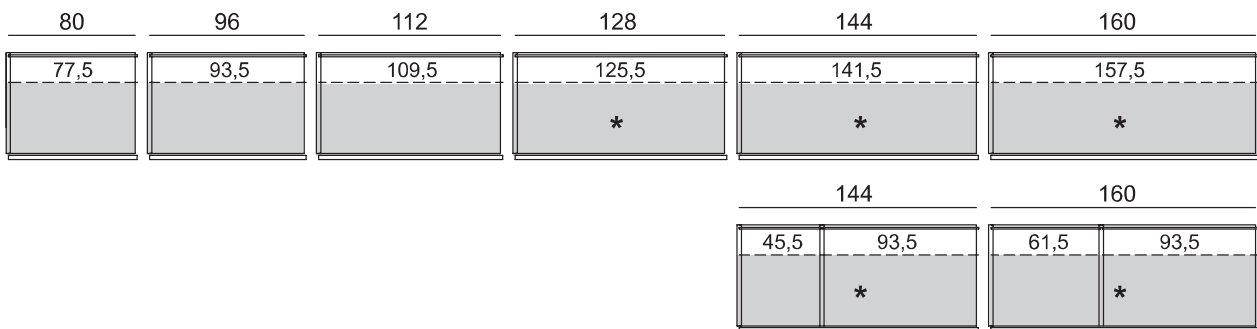

ALTEZZA

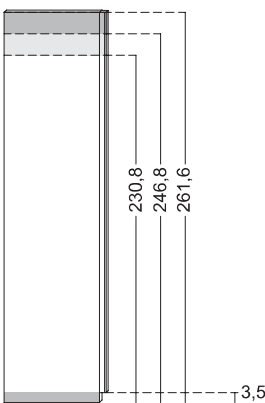

PROFONDITÀ

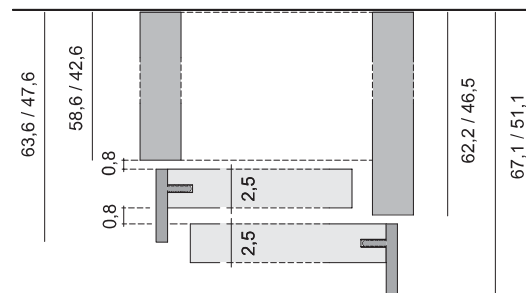

Riduzioni struttura

RIDUZIONE in LARGHEZZA

Il prezzo della riduzione è comprensivo dei tagli:

- Coperchio
- Base
- 1 ripiano
- Schienale

- Anta

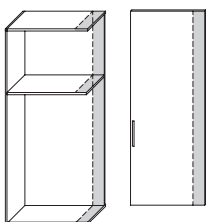

RIDUZIONE in PROFONDITÀ

Il prezzo della riduzione è comprensivo dei tagli e foratura supplementare:

- Coperchio
- Base
- 1 ripiano
- 1 fianco

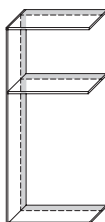

RIDUZIONE in ALTEZZA

Il prezzo della riduzione è comprensivo dei tagli:

- Fianco
- Schienale

- Anta

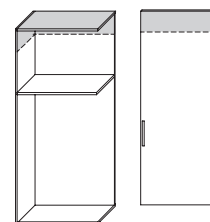

Anta scorrevole STRIP - Composizioni



- Armadi P. cm 42,6 stesso prezzo
- Prezzi comprensivi di finitura fianchi come anta "A"
- Incluso un ripiano strutturale Sp. cm 4 a modulo

- Il prezzo si riferisce ai pannelli "A"
- Il pannello "B" è disponibile in tutte le nostre finiture (escluso laccato lucido) senza differenza di prezzo.
- Possibilità di inserimento **PORTA TV GHOST** vedi pag.392

2 ANTE

	H.	Codice	Essenza 1	Essenza 2	Laccato Opaco
<p>L. cm 162,5</p>	230,8	CS3A05			
	246,8	CS4A05			
	261,6	CS6A05			
<p>L. cm 194,5</p>	230,8	CS3B05			
	246,8	CS4B05			
	261,6	CS6B05			
<p>L. cm 226,5</p>	230,8	CS3C05			
	246,8	CS4C05			
	261,6	CS6C05			
<p>L. cm 258,5</p>	230,8	CS3D05			
	246,8	CS4D05			
	261,6	CS6D05			
<p>L. cm 290,5</p>	230,8	CS3E05			
	246,8	CS4E05			
	261,6	CS6E05			
<p>L. cm 322,5</p>	230,8	CS3F05			
	246,8	CS4F05			
	261,6	CS6F05			

3 ANTE

	H.	Codice	Essenza 1	Essenza 2	Laccato Opaco
<p>L. cm 242,5</p>	230,8	CS3G05			
	246,8	CS4G05			
	261,6	CS6G05			
<p>L. cm 290,5</p>	230,8	CS3H05			
	246,8	CS4H05			
	261,6	CS6H05			
<p>L. cm 338,5</p>	230,8	CS3L05			
	246,8	CS4L05			
	261,6	CS6L05			
<p>L. cm 386,5</p>	230,8	CS3M05			
	246,8	CS4M05			
	261,6	CS6M05			

**Il prezzo del modulo
comprende:**

- 1 fianco struttura Sp. cm 2,5
- 1 ripiano interno Sp. cm 4

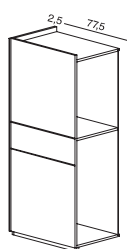

L. cm 80

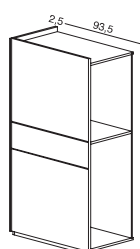

L. cm 96

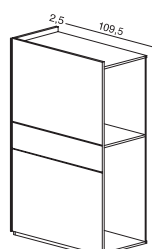

L. cm 112

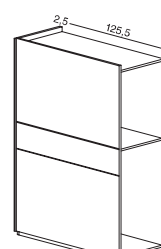

L. cm 128

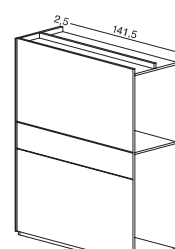

L. cm 144

H. 230,8	Codice	S3805	S3905	S3205	S3105	S3145C
Essenza 1						
Essenza 2						
Laccato opaco						

H. 246,8		S4805	S4905	S4205	S4105	S4145C
Essenza 1						
Essenza 2						
Laccato opaco						

H. 261,6		S6805	S6905	S6205	S6105	S6145C
Essenza 1						
Essenza 2						
Laccato opaco						

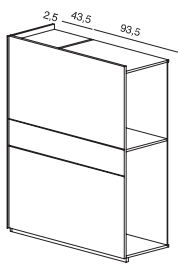

L. cm 144

S3145

1.965

1.843

1.780

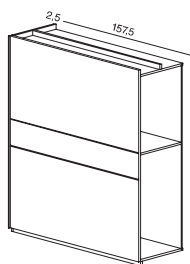

L. cm 160

S3165C

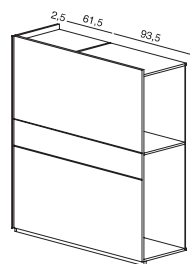

L. cm 160

S3165

Fianco terminale
in melaminico

Supplemento
finitura fianchi
esterni (cad.)



Sp. cm 2,5

S31



FF31

CASSETTIERE interne 4 cassetti
con guide ammortizzate

Per estrazione totale aggiungere
per cassetto



- L. cm 45,5
- L. cm 61,5
- L. cm 77,5
- L. cm 93,5
- L. cm 109,5
- L. cm 125,5

S4145

S4165C

S4165

S46

FF46

1.965

1.843

1.780

Ripiani interni



Sp. 2,5 | Sp. 4

- L. 45,5
- L. 61,5
- L. 77,5
- L. 93,5
- L. 109,5
- L. 125,5
- L. 141,5
- L. 157,5

S6145

S6165C

S6165

S62

FF62

1.965

1.843

1.780

Tubi appendiabiti alluminio



- L. 45,5
- L. 61,5
- L. 77,5
- L. 93,5
- L. 109,5
- L. 125,5
- L. 141,5
- L. 157,5

ANTA SHEALD 3



Maniglia profilo verticale a tutta altezza



Anta scorrevole SHEALD 3 - Caratteristiche, modularità e finiture

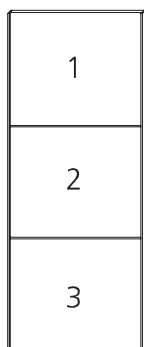

Anta Scorrevole SHEALD 3

Anta spessore mm 25 in agglomerato superleggero con profilo maniglia verticale L, mm 6 - regolatori tendi anta e profilo parapolvere. Carrelli di scorrimento dotati di fermo ammortizzato in apertura e chiusura.
N.B.: l'anta viene consegnata assemblata salvo diverse indicazioni in fase d'ordine.

Finiture previste anta SHEALD 3

Essenze nostro campionario impiallacciato orizzontale
 Laccato opaco

Finiture previste maniglia

Tutte le Essenze ad esclusione della Quercia
 Laccato opaco

1 / 2 / 3

La suddivisione in altezza dell'anta in TRE pannelli è totalmente libera per misura e finiture. Ogni singolo pannello che compone l'anta può essere realizzato su misura in ALTEZZA min. cm 8 - max cm 120.

LARGHEZZA

- Moduli con struttura P. cm 58,6
- Moduli con struttura P. cm 42,6

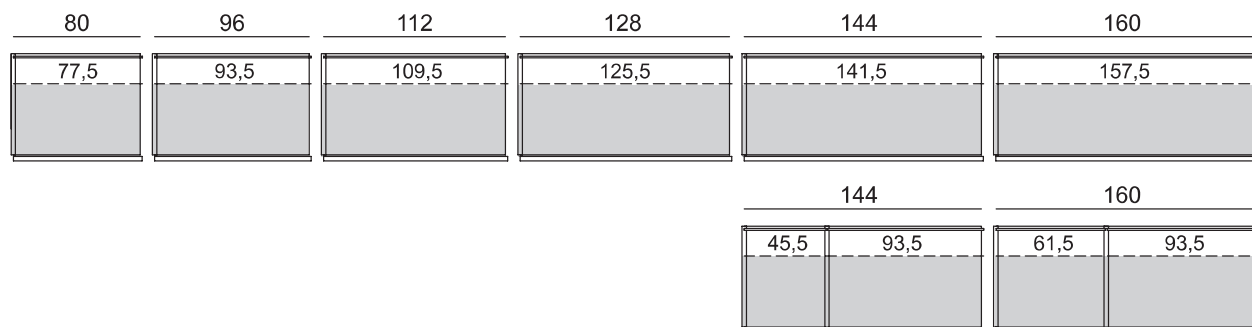

ALTEZZA

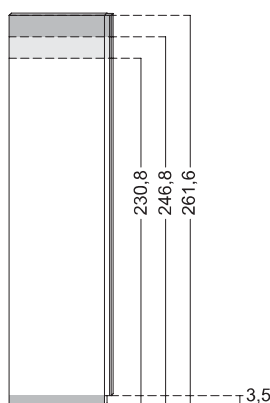

PROFONDITÀ

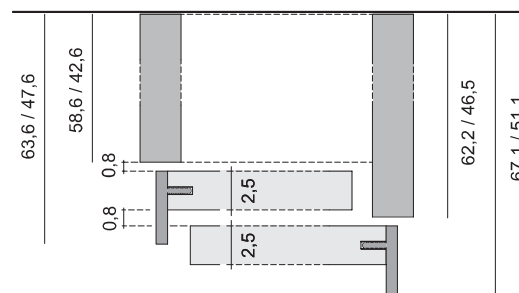

Riduzioni struttura

RIDUZIONE in LARGHEZZA

Il prezzo della riduzione è comprensivo dei tagli:

- Coperchio
- Base
- 1 ripiano
- Schienale

- Anta

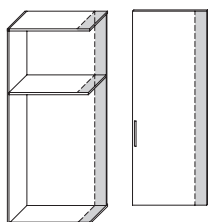

RIDUZIONE in PROFONDITÀ

Il prezzo della riduzione è comprensivo dei tagli e foratura supplementare:

- Coperchio
- Base
- 1 ripiano
- 1 fianco

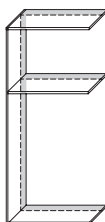

RIDUZIONE in ALTEZZA

Il prezzo della riduzione è comprensivo dei tagli:

- Fianco
- Schienale

- Anta

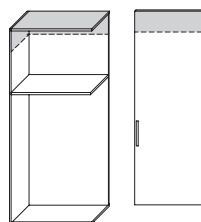

Anta scorrevole SHEALD 3 - Composizioni



- Armadi P. cm 42,6 stesso prezzo
- Prezzi comprensivi di finitura fianchi come anta
- Incluso un ripiano strutturale Sp. cm 4 a modulo

N.B.: per ante composte Essenza/Laccato considerare prezzo essenza.

2 ANTE

	H.	Codice	Essenza 1	Essenza 2	Laccato Opaco
<p>L. cm 162,5</p>	230,8	CS3A05B			
	246,8	CS4A05B			
	261,6	CS6A05B			
<p>L. cm 194,5</p>	230,8	CS3B05B			
	246,8	CS4B05B			
	261,6	CS6B05B			
<p>L. cm 194,5</p>	230,8	CS3C05B			
	246,8	CS4C05B			
	261,6	CS6C05B			
<p>L. cm 258,5</p>	230,8	CS3D05B			
	246,8	CS4D05B			
	261,6	CS6D05B			
<p>L. cm 290,5</p>	230,8	CS3E05B			
	246,8	CS4E05B			
	261,6	CS6E05B			
<p>L. cm 322,5</p>	230,8	CS3F05B			
	246,8	CS4F05B			
	261,6	CS6F05B			

3 ANTE

	H.	Codice	Essenza 1	Essenza 2	Laccato Opaco
<p>L. cm 242,5</p>	230,8	CS3G05B			
	246,8	CS4G05B			
	261,6	CS6G05B			
<p>L. cm 290,5</p>	230,8	CS3H05B			
	246,8	CS4H05B			
	261,6	CS6H05B			
<p>L. cm 338,5</p>	230,8	CS3L05B			
	246,8	CS4L05B			
	261,6	CS6L05B			
<p>L. cm 386,5</p>	230,8	CS3M05B			
	246,8	CS4M05B			
	261,6	CS6M05B			

Moduli armadio anta scorrevole SHEALD 3

N.B.: per ante composte Essenza/Laccato considerare prezzo essenza.

Il prezzo del modulo comprende:

- 1 fianco struttura Sp. cm 2,5
- 1 ripiano interno Sp. cm 4

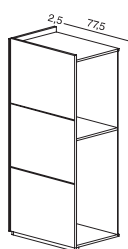

L. cm 80

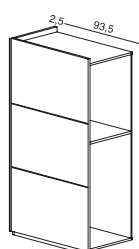

L. cm 96

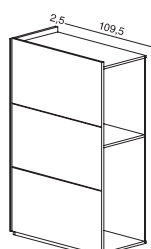

L. cm 112

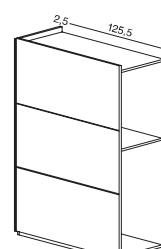

L. cm 128

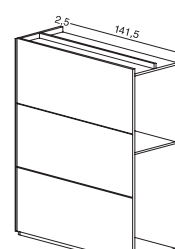

L. cm 144

H. 230,8	Codice	S3805B	S3905B	S3205B	S3105B	S3145CB
Essenza 1						
Essenza 2						
Laccato opaco						

H. 246,8		S4805B	S4905B	S4205B	S4105B	S4145CB
Essenza 1						
Essenza 2						
Laccato opaco						

H. 261,6		S6805B	S6905B	S6205B	S6105B	S6145CB
Essenza 1						
Essenza 2						
Laccato opaco						

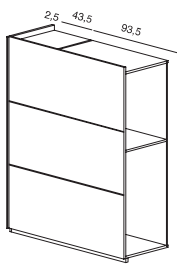

L. cm 144

S3145B

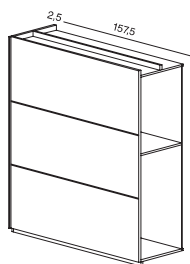

L. cm 160

S3165CB

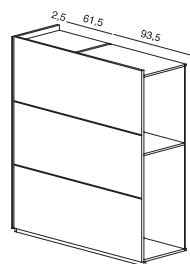

L. cm 160

S3165B

Fianco terminale
in melaminico

Supplemento
finitura fianchi
esterni (cad.)



Sp. cm 2,5

S31



FF31

CASSETTIERE interne 4 cassetti
con guide ammortizzate

Per estrazione totale aggiungere
per cassetto



- L. cm 45,5
- L. cm 61,5
- L. cm 77,5
- L. cm 93,5
- L. cm 109,5
- L. cm 125,5

S4145B

S4165CB

S4165B

S46

FF46

Ripiani interni



Sp. 2,5 | Sp. 4

- L. 45,5
- L. 61,5
- L. 77,5
- L. 93,5
- L. 109,5
- L. 125,5
- L. 141,5
- L. 157,5

S6145B

S6165CB

S6165B

S62

FF62

Tubi appendiabiti alluminio



- L. 45,5
- L. 61,5
- L. 77,5
- L. 93,5
- L. 109,5
- L. 125,5
- L. 141,5
- L. 157,5

ANTA SHEALD 4

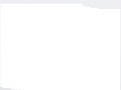

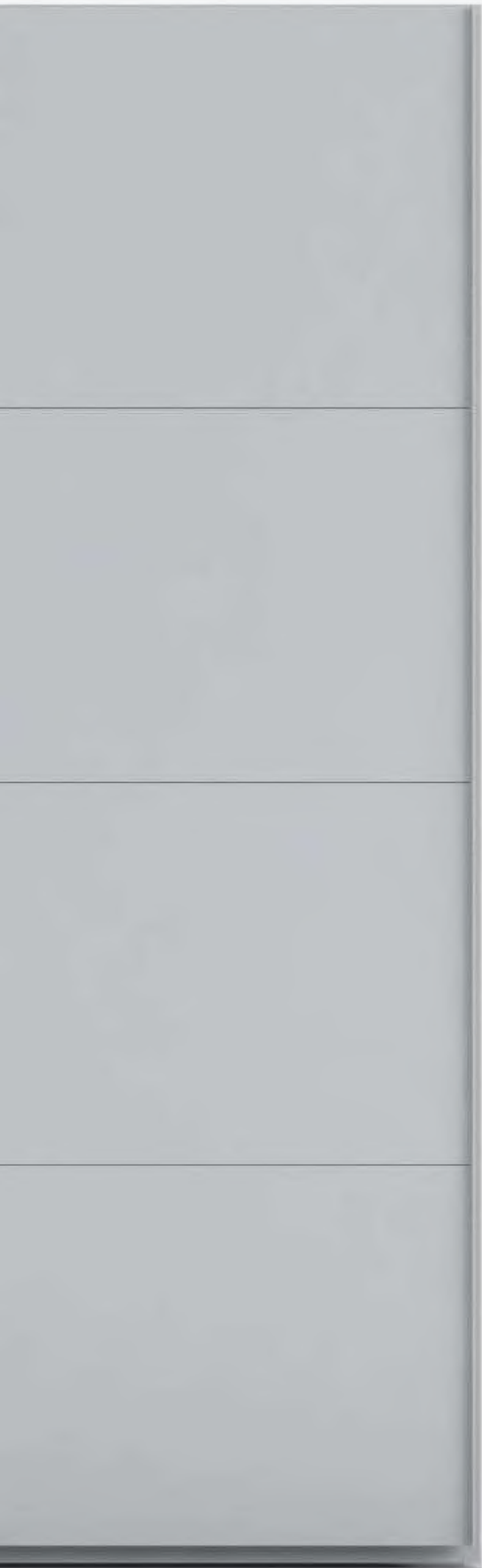

Maniglia profilo verticale a tutta altezza



Anta scorrevole SHEALD 4 - Caratteristiche, modularità e finiture

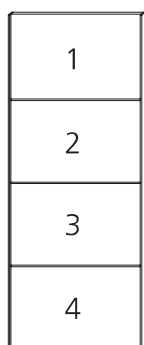

Anta Scorrevole SHEALD 4

Anta spessore mm 25 in agglomerato superleggero con profilo maniglia verticale L, mm 6 - regolatori tendi anta e profilo parapolvere. Carrelli di scorrimento dotati di fermo ammortizzato in apertura e chiusura. **N.B.:** l'anta viene consegnata assemblata salvo diverse indicazioni in fase d'ordine.

Finiture previste anta SHEALD 4

Essenze nostro campionario impiallacciato orizzontale
Laccato opaco

Finiture previste maniglia

Tutte le Essenze ad esclusione della Quercia
Laccato opaco

1 / 2 / 3 / 4

La suddivisione in altezza dell'anta in QUATTRO pannelli è totalmente libera per misura e finiture. Ogni singolo pannello che compone l'anta può essere realizzato su misura in ALTEZZA min. cm 8 - max cm 120.

LARGHEZZA

- Moduli con struttura P. cm 58,6
- Moduli con struttura P. cm 42,6

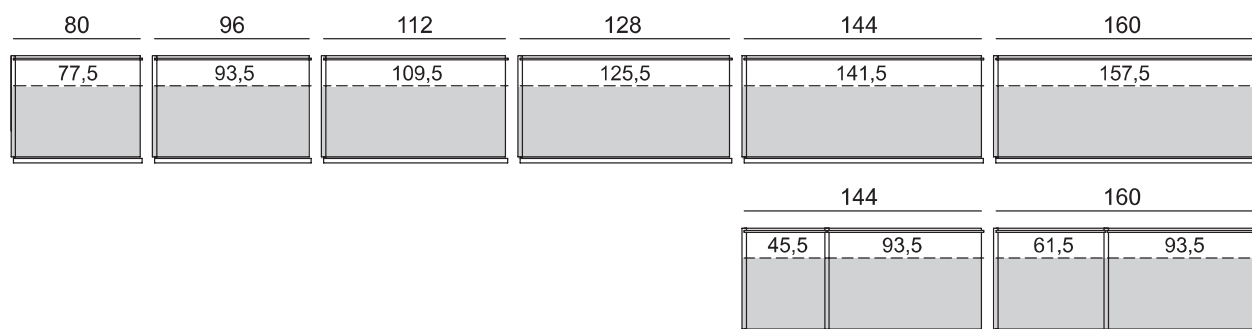

ALTEZZA

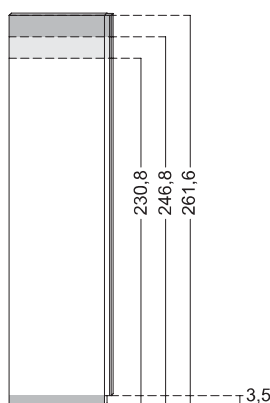

PROFONDITÀ

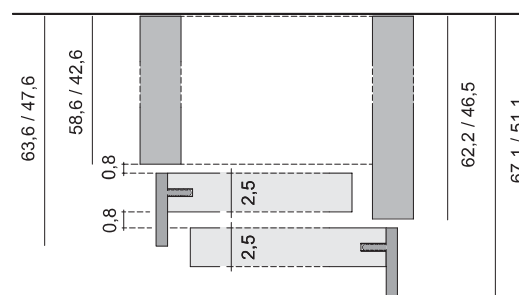

Riduzioni struttura

RIDUZIONE in LARGHEZZA

Il prezzo della riduzione è comprensivo dei tagli:

- Coperchio
- Base
- 1 ripiano
- Schienale

- Anta

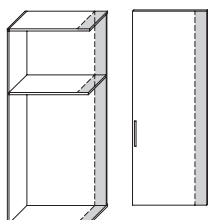

RIDUZIONE in PROFONDITÀ

Il prezzo della riduzione è comprensivo dei tagli e foratura supplementare:

- Coperchio
- Base
- 1 ripiano
- 1 fianco

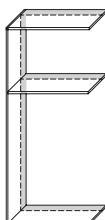

RIDUZIONE in ALTEZZA

Il prezzo della riduzione è comprensivo dei tagli:

- Fianco
- Schienale

- Anta

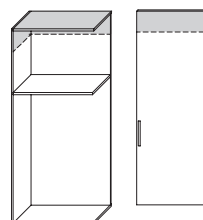

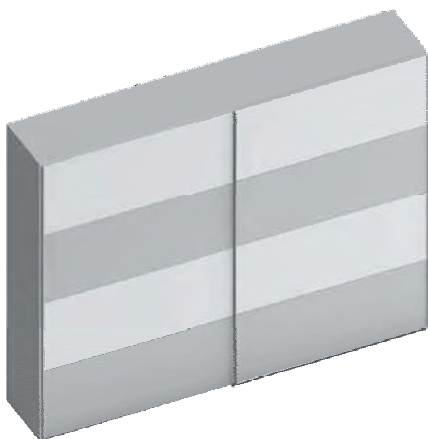

Anta scorrevole SHEALD 4 - Composizioni



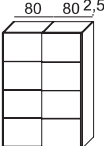
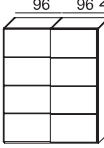
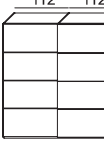
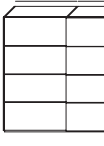
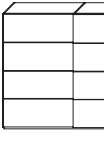

- Armadi P. cm 42,6 stesso prezzo
- Prezzi comprensivi di finitura fianchi come anta
- Incluso un ripiano strutturale Sp. cm 4 a modulo

N.B.: per ante composte Essenza/Laccato considerare prezzo essenza.

2 ANTE

	H.	Codice	Essenza 1	Essenza 2	Laccato Opaco
 L. cm 162,5	230,8	CS3A05C			
	246,8	CS4A05C			
	261,6	CS6A05C			
 L. cm 194,5	230,8	CS3B05C			
	246,8	CS4B05C			
	261,6	CS6B05C			
 L. cm 226,5	230,8	CS3C05C			
	246,8	CS4C05C			
	261,6	CS6C05C			
 L. cm 258,5	230,8	CS3D05C			
	246,8	CS4D05C			
	261,6	CS6D05C			
 L. cm 290,5	230,8	CS3E05C			
	246,8	CS4E05C			
	261,6	CS6E05C			
 L. cm 322,5	230,8	CS3F05C			
	246,8	CS4F05C			
	261,6	CS6F05C			

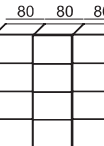
3 ANTE

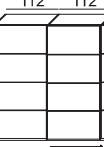
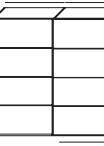
	H.	Codice	Essenza 1	Essenza 2	Laccato Opaco
 L. cm 242,5	230,8	CS3G05C			
	246,8	CS4G05C			
	261,6	CS6G05C			
 L. cm 290,5	230,8	CS3H05C			
	246,8	CS4H05C			
	261,6	CS6H05C			
 L. cm 338,5	230,8	CS3L05C			
	246,8	CS4L05C			
	261,6	CS6L05C			
 L. cm 386,5	230,8	CS3M05C			
	246,8	CS4M05C			
	261,6	CS6M05C			

Moduli armadio anta scorrevole SHEALD 4

N.B.: per ante composte Essenza/Laccato considerare prezzo essenza.

Il prezzo del modulo comprende:

- 1 fianco struttura Sp. cm 2,5
- 1 ripiano interno Sp. cm 4

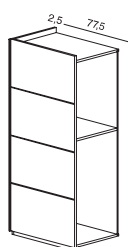

L. cm 80

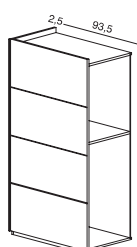

L. cm 96

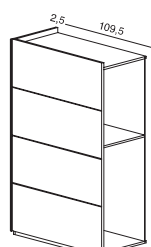

L. cm 112

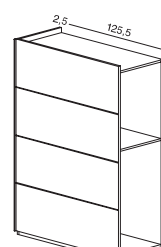

L. cm 128

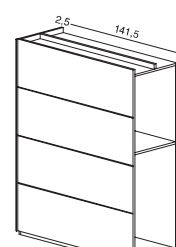

L. cm 144

H. 230,8

Codice

S3805C

S3905C

S3205C

S3105C

S3145CC

Essenza 1

Essenza 2

Laccato opaco

H. 246,8

S4805C

S4905C

S4205C

S4105C

S4145CC

Essenza 1

Essenza 2

Laccato opaco

H. 261,6

S6805C

S6905C

S6205C

S6105C

S6145CC

Essenza 1

Essenza 2

Laccato opaco

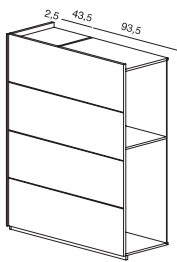

L. cm 144

S3145C

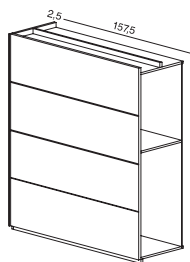

L. cm 160

S3165CC

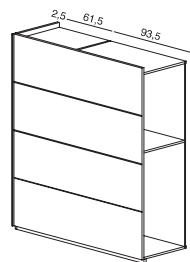

L. cm 160

S3165C

Fianco terminale
in melaminico

Supplemento
finitura fianchi
esterni (cad.)

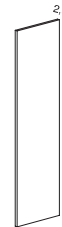

Sp. cm 2,5

S31



FF31

CASSETTIERE interne 4 cassetti
con guide ammortizzate

Per estrazione totale aggiungere
per cassetto



- L. cm 45,5
- L. cm 61,5
- L. cm 77,5
- L. cm 93,5
- L. cm 109,5
- L. cm 125,5

S4145C

S4165CC

S4165C

S46

FF46

Ripiani interni



Sp. 2,5 | Sp. 4

- L. 45,5
- L. 61,5
- L. 77,5
- L. 93,5
- L. 109,5
- L. 125,5
- L. 141,5
- L. 157,5

S6145C

S6165CC

S6165C

S62

FF62

Tubi appendiabiti alluminio



- L. 45,5
- L. 61,5
- L. 77,5
- L. 93,5
- L. 109,5
- L. 125,5
- L. 141,5
- L. 157,5

ANTA EMOTION

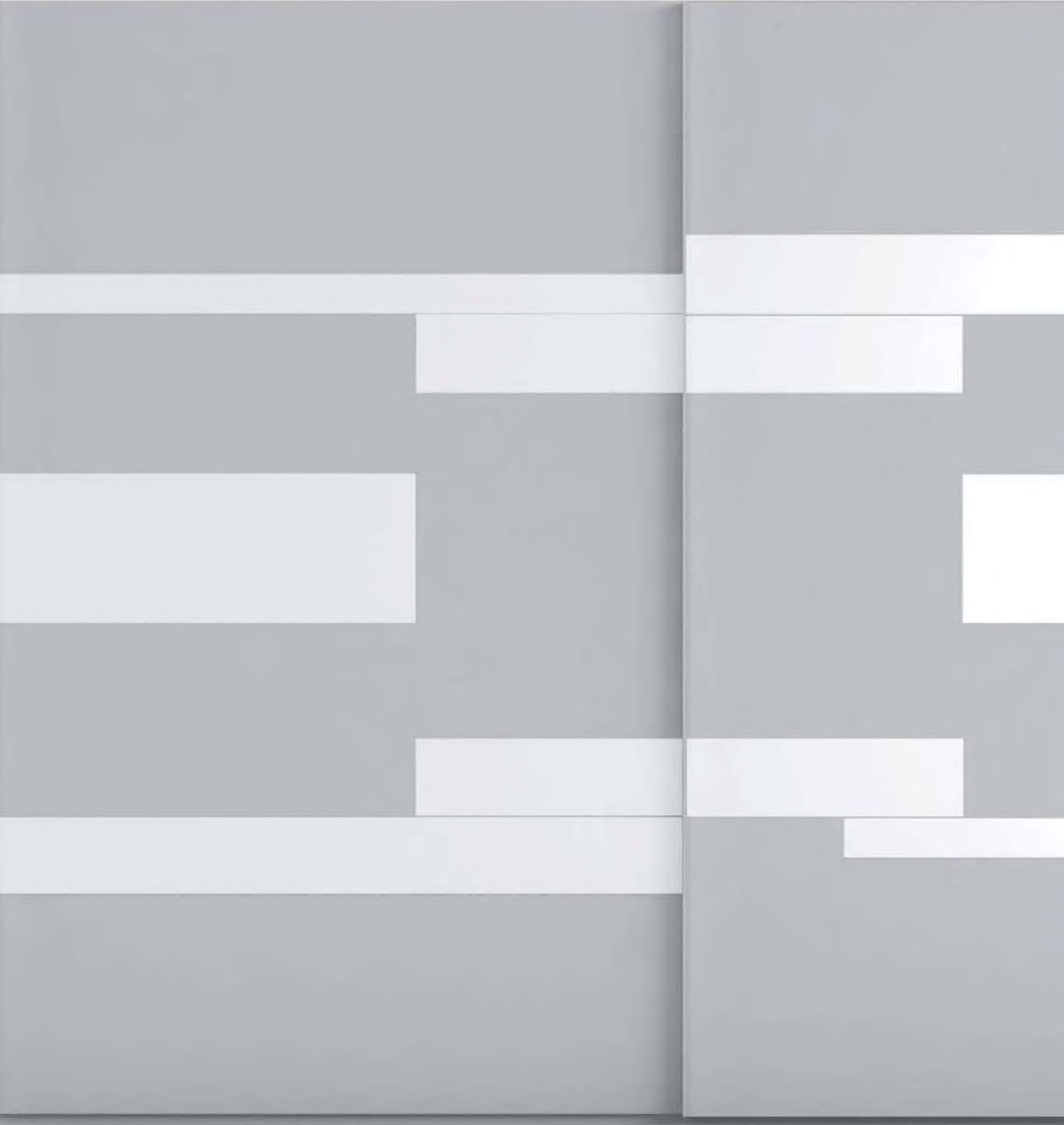



Maniglia profilo verticale a tutta altezza

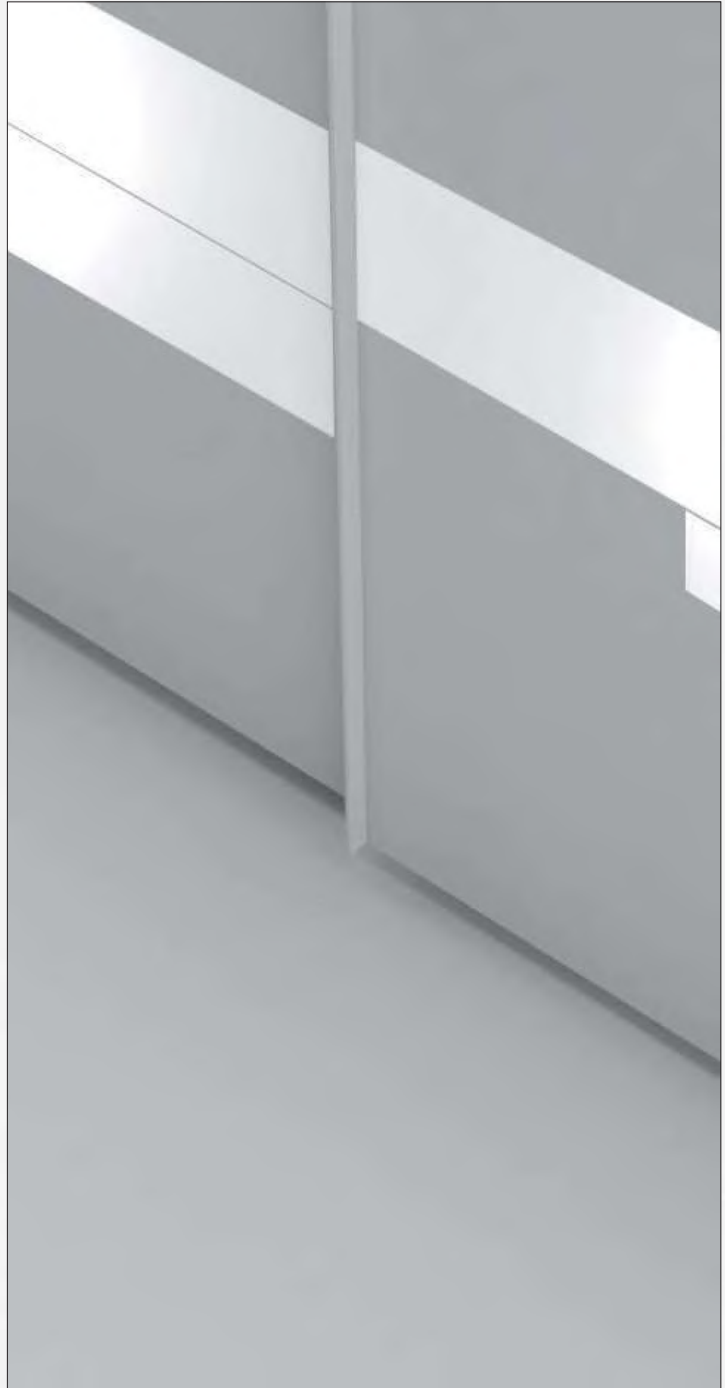

Anta scorrevole EMOTION - Caratteristiche, modularità e finiture

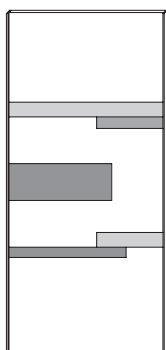

Anta Scorrevole EMOTION

Anta spessore mm 25 in agglomerato superleggero divisa in tre settori con profilo maniglia verticale L, mm 6 - regolatori tendi anta e profilo parapolvere. Inserti in vetro o in essenza incassati a filo.
Carrelli di scorrimento dotati di fermo ammortizzato in apertura e chiusura.
N.B.: l'anta viene consegnata assemblata salvo diverse indicazioni in fase d'ordine.

Finiture previste anta EMOTION

Essenze nostro campionario impiallacciato in orizzontale
Laccato opaco
Inserti in vetro extrachiaro laccato, satinato laccato o essenze a campionario.

Finiture previste maniglia

Tutte le Essenze ad esclusione della Quercia
Laccato opaco

LARGHEZZA

- Moduli con struttura P. cm 58,6
- Moduli con struttura P. cm 42,6

* Possibilità di inserimento
Porta TV GHOST (vedi pag.392)

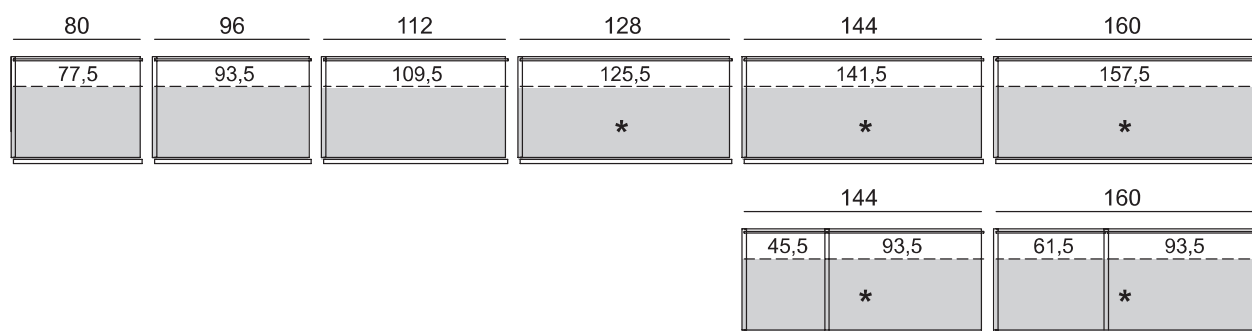

ALTEZZA

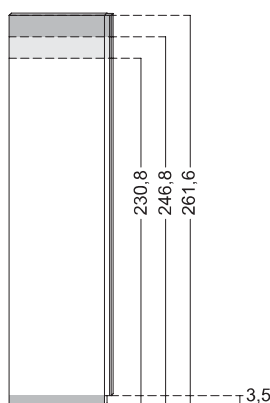

PROFONDITÀ

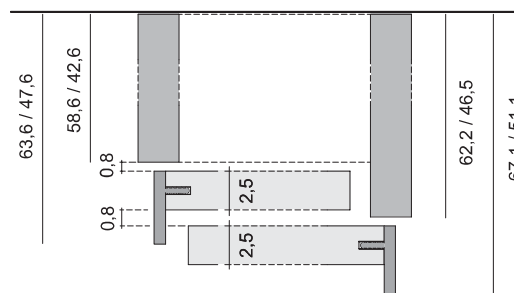

Riduzioni struttura

RIDUZIONE in LARGHEZZA

Il prezzo della riduzione è comprensivo dei tagli:

- Coperchio
- Base
- 1 ripiano
- Schienale

- Anta

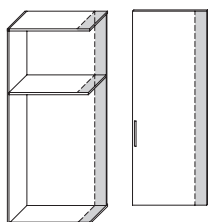

RIDUZIONE in PROFONDITÀ

Il prezzo della riduzione è comprensivo dei tagli e foratura supplementare:

- Coperchio
- Base
- 1 ripiano
- 1 fianco

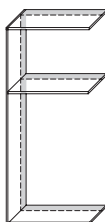

RIDUZIONE in ALTEZZA

Il prezzo della riduzione è comprensivo dei tagli:

- Fianco
- Schienale

- Anta

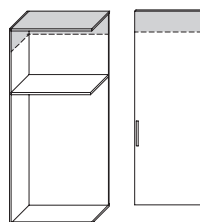

Anta scorrevole EMOTION - Composizioni



- Armadi P. cm 42,6 stesso prezzo
- Prezzi comprensivi di finitura fianchi come anta
- Incluso un ripiano strutturale Sp. cm 4 a modulo

- Il prezzo si riferisce alle ante
 Gli inserti sono disponibili in tutte le nostre finiture (escluso laccato lucido) senza differenza di prezzo.

Possibilità di inserimento **PORTA TV GHOST** vedi pag.392

2 ANTE

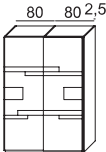
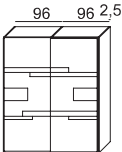
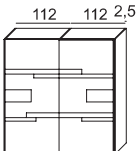
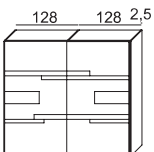
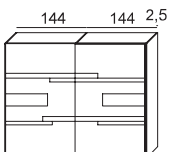
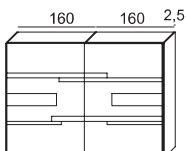
	H.	Codice	Essenza 1	Essenza 2	Laccato Opaco
 L. cm 162,5	230,8	CS3A06			
	246,8	CS4A06			
	261,6	CS6A06			
 L. cm 194,5	230,8	CS3B06			
	246,8	CS4B06			
	261,6	CS6B06			
 L. cm 226,5	230,8	CS3C06			
	246,8	CS4C06			
	261,6	CS6C06			
 L. cm 258,5	230,8	CS3D06			
	246,8	CS4D06			
	261,6	CS6C06			
 L. cm 290,5	230,8	CS3E06			
	246,8	CS4E06			
	261,6	CS6E06			
 L. cm 322,5	230,8	CS3F06			
	246,8	CS4F06			
	261,6	CS6F06			

3 ANTE

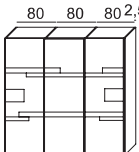
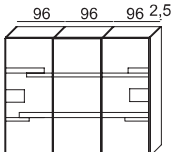
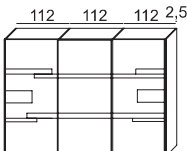
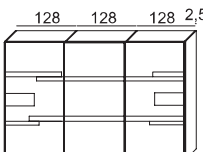
	H.	Codice	Essenza 1	Essenza 2	Laccato Opaco
 L. cm 242,5	230,8	CS3G06			
	246,8	CS4G06			
	261,6	CS6G06			
 L. cm 290,5	230,8	CS3H06			
	246,8	CS4H06			
	261,6	CS6H06			
 L. cm 338,5	230,8	CS3L06			
	246,8	CS4L06			
	261,6	CS6L06			
 L. cm 386,5	230,8	CS3M06			
	246,8	CS4M06			
	261,6	CS6M06			

Moduli armadio anta scorrevole EMOTION

Il prezzo del modulo comprende:

- 1 fianco struttura Sp. cm 2,5
- 1 ripiano interno Sp. cm 4

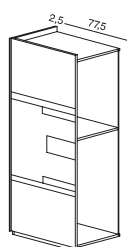

L. cm 80

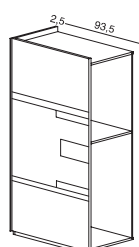

L. cm 96

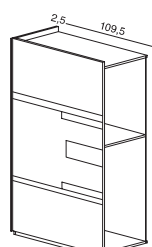

L. cm 112

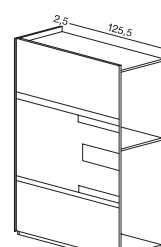

L. cm 128

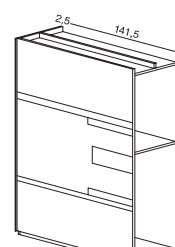

L. cm 144

H. 230,8	Codice	S3806	S3906	S3206	S3106	S3146C
Essenza 1						
Essenza 2						
Laccato opaco						

H. 246,8		S4806	S4906	S4206	S4106	S4146C
Essenza 1						
Essenza 2						
Laccato opaco						

H. 261,6		S6806	S6906	S6206	S6106	S6146C
Essenza 1						
Essenza 2						
Laccato opaco						

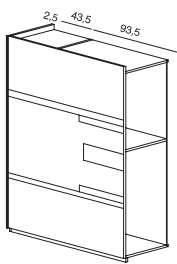

L. cm 144

S3146

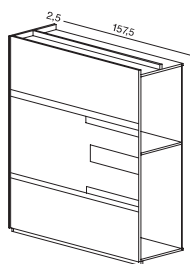

L. cm 160

S3166C

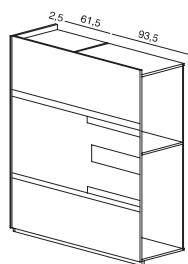

L. cm 160

S3166

Fianco terminale
in melaminico

Supplemento
finitura fianchi
esterni (cad.)

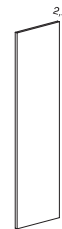

Sp. cm 2,5

S31



FF31

CASSETTIERE interne 4 cassetti
con guide ammortizzate

Per estrazione totale aggiungere
per cassetto + € 30



- L. cm 45,5
- L. cm 61,5
- L. cm 77,5
- L. cm 93,5
- L. cm 109,5
- L. cm 125,5

S4146

S4166C

S4166

S46

FF46

Ripiani interni



Sp. 2,5 | Sp. 4

- L. 45,5
- L. 61,5
- L. 77,5
- L. 93,5
- L. 109,5
- L. 125,5
- L. 141,5
- L. 157,5

S6146

S6166C

S6166

S62

FF62

Tubi appendiabiti alluminio



- L. 45,5
- L. 61,5
- L. 77,5
- L. 93,5
- L. 109,5
- L. 125,5
- L. 141,5
- L. 157,5

ANTA EMOTION BASIC

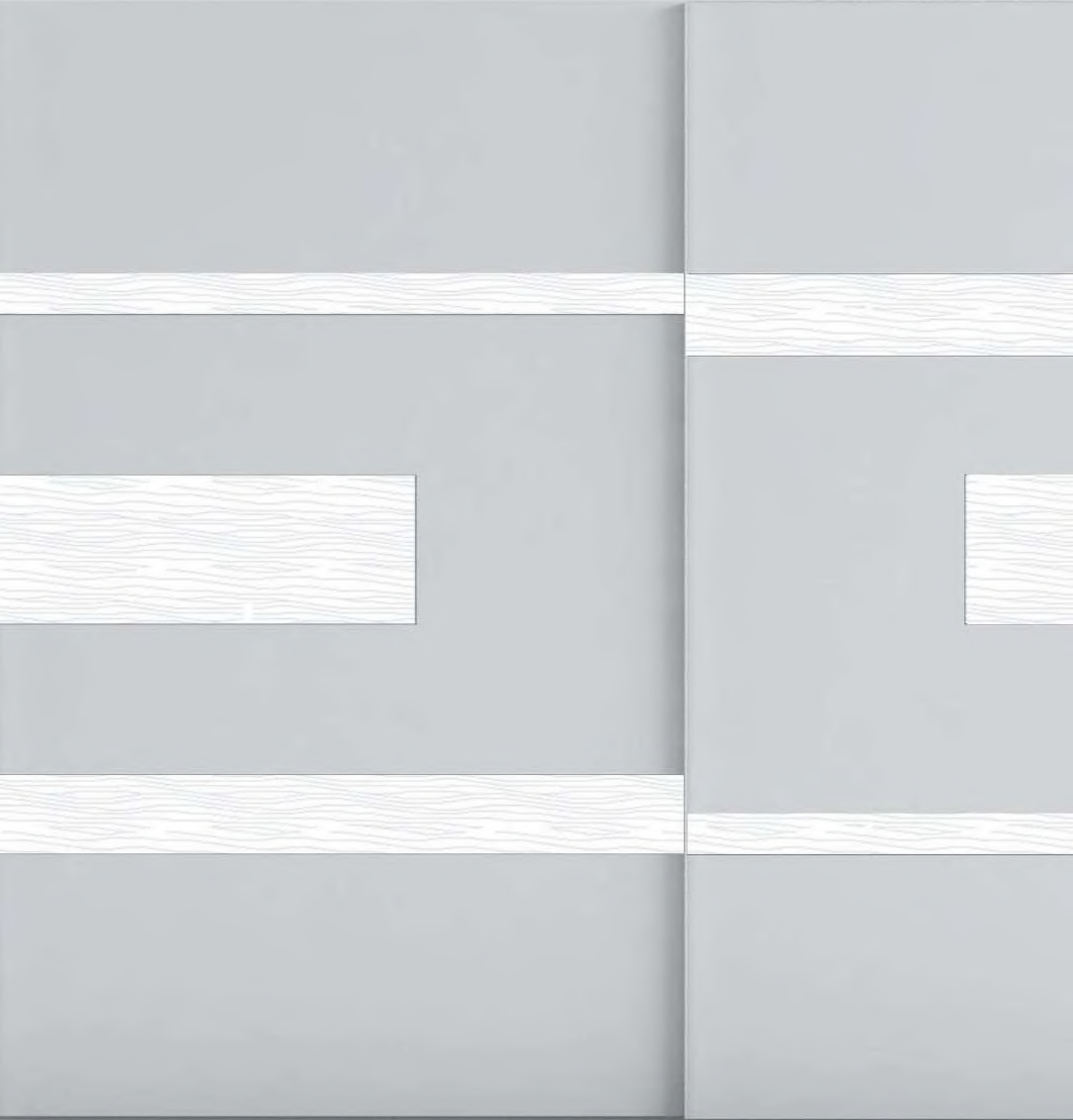



Maniglia profilo verticale a tutta altezza



Anta scorrevole EMOTION BASIC - Caratteristiche, modularità e finiture

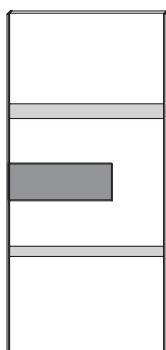

Anta Scorrevole EMOTION BASIC

Anta spessore mm 25 in agglomerato superleggero divisa in tre settori con profilo maniglia verticale L, mm 6 - regolatori tendi anta e profilo parapolvere. Inserti in vetro o in essenza incassati a filo.

Carrelli di scorrimento dotati di fermo ammortizzato in apertura e chiusura.

N.B.: l'anta viene consegnata assemblata salvo diverse indicazioni in fase d'ordine.

Finiture previste anta EMOTION BASIC

Essenze nostro campionario impiallacciato in orizzontale

Laccato opaco

Inserti in vetro extrachiaro laccato, satinato laccato o essenze a campionario.

Finiture previste maniglia

Tutte le Essenze ad esclusione della Quercia

Laccato opaco

LARGHEZZA

□ Moduli con struttura P. cm 58,6

■ Moduli con struttura P. cm 42,6

* Possibilità di inserimento

Porta TV GHOST (vedi pag.392)

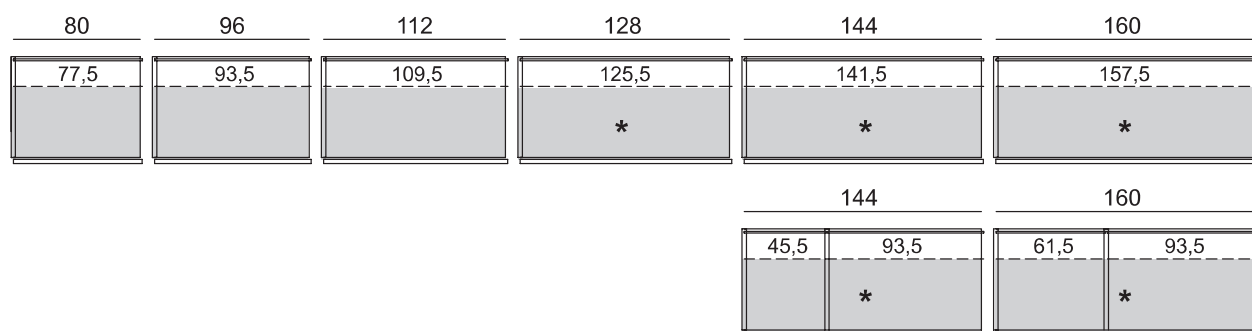

ALTEZZA

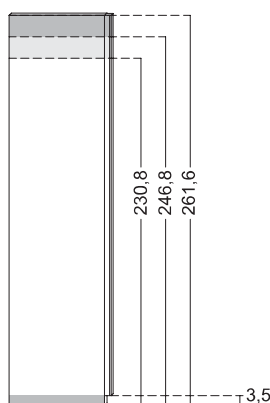

PROFONDITÀ

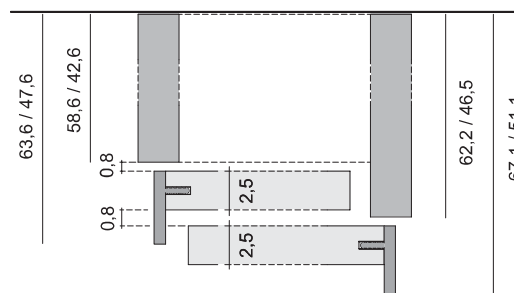

Riduzioni struttura

RIDUZIONE in LARGHEZZA

Il prezzo della riduzione è comprensivo dei tagli:

- Coperchio
- Base
- 1 ripiano
- Schienale

- Anta

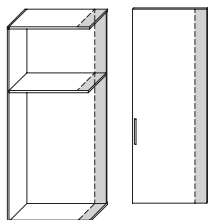

RIDUZIONE in PROFONDITÀ

Il prezzo della riduzione è comprensivo dei tagli e foratura supplementare:

- Coperchio
- Base
- 1 ripiano
- 1 fianco

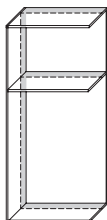

RIDUZIONE in ALTEZZA

Il prezzo della riduzione è comprensivo dei tagli:

- Fianco
- Schienale

- Anta

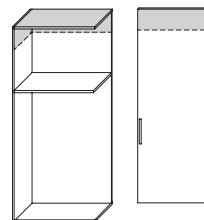

Anta scorrevole EMOTION BASIC - Composizioni



- Armadi P. cm 42,6 stesso prezzo
- Prezzi comprensivi di finitura fianchi come anta
- Incluso un ripiano strutturale Sp. cm 4 a modulo

- Il prezzo si riferisce alle ante
 Gli inserti sono disponibili in tutte le nostre finiture (escluso laccato lucido) senza differenza di prezzo.

Possibilità di inserimento **PORTA TV GHOST** vedi pag.392

2 ANTE

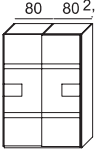
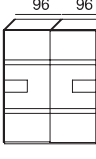
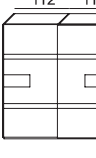
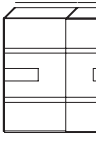
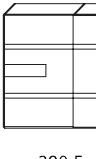
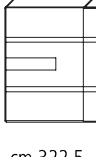
	H.	Codice	Essenza 1	Essenza 2	Laccato Opaco
 L. cm 162,5	230,8	CS3A06B			
	246,8	CS4A06B			
	261,6	CS6A06B			
 L. cm 194,5	230,8	CS3B06B			
	246,8	CS4B06B			
	261,6	CS6B06B			
 L. cm 226,5	230,8	CS3C06B			
	246,8	CS4C06B			
	261,6	CS6C06B			
 L. cm 258,5	230,8	CS3D06B			
	246,8	CS4D06B			
	261,6	CS6D06B			
 L. cm 290,5	230,8	CS3E06B			
	246,8	CS4E06B			
	261,6	CS6E06B			
 L. cm 322,5	230,8	CS3F06B			
	246,8	CS4F06B			
	261,6	CS6F06B			

3 ANTE

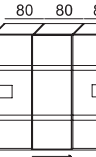
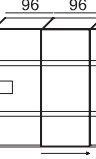
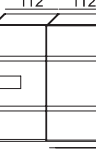
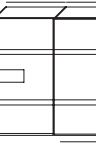
	H.	Codice	Essenza 1	Essenza 2	Laccato Opaco
 L. cm 242,5	230,8	CS3G06B			
	246,8	CS4G06B			
	261,6	CS6G06B			
 L. cm 290,5	230,8	CS3H06B			
	246,8	CS4H06B			
	261,6	CS6H06B			
 L. cm 338,5	230,8	CS3L06B			
	246,8	CS4L06B			
	261,6	CS6L06B			
 L. cm 386,5	230,8	CS3M06B			
	246,8	CS4M06B			
	261,6	CS6M06B			

Moduli armadio anta scorrevole EMOTION BASIC

Il prezzo del modulo comprende:

- 1 fianco struttura Sp. cm 2,5
- 1 ripiano interno Sp. cm 4

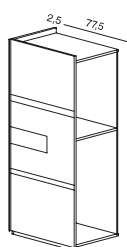

L. cm 80

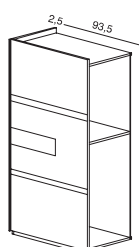

L. cm 96

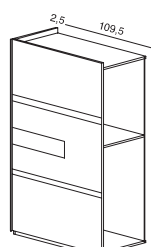

L. cm 112

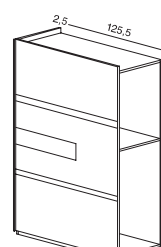

L. cm 128

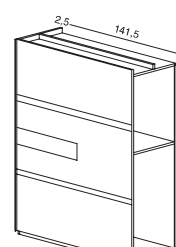

L. cm 144

H. 230,8	Codice	S3806B	S3906B	S3206B	S3106B	S3146CB
Essenza 1						
Essenza 2						
Laccato opaco						

H. 246,8		S4806B	S4906B	S4206B	S4106B	S4146CB
Essenza 1						
Essenza 2						
Laccato opaco						

H. 261,6		S6806B	S6906B	S6206B	S6106B	S6146CB
Essenza 1						
Essenza 2						
Laccato opaco						

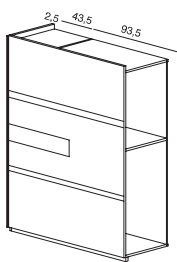

L. cm 144

S3146B

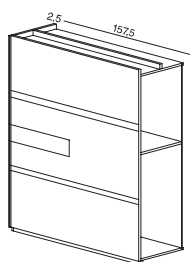

L. cm 160

S3166CB

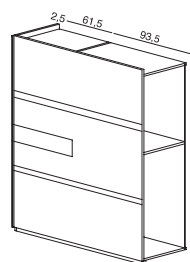

L. cm 160

S3166B

Fianco terminale
in melaminico

Supplemento
finitura fianchi
esterni (cad.)



Sp. cm 2,5

S31



FF31

CASSETTIERE interne 4 cassetti
con guide ammortizzate

Per estrazione totale aggiungere
per cassetto



- L. cm 45,5
- L. cm 61,5
- L. cm 77,5
- L. cm 93,5
- L. cm 109,5
- L. cm 125,5

S4146B

S4166CB

S4166B

S46

FF46

Ripiani interni



Sp. 2,5 | Sp. 4

- L. 45,5
- L. 61,5
- L. 77,5
- L. 93,5
- L. 109,5
- L. 125,5
- L. 141,5
- L. 157,5

S6146B

S6166CB

S6166B

S62

FF62

Tubi appendiabiti alluminio



- L. 45,5
- L. 61,5
- L. 77,5
- L. 93,5
- L. 109,5
- L. 125,5
- L. 141,5
- L. 157,5

ANTA MAX4



Anta in forte spessore con micro maniglia sul bordo



Anta scorrevole MAX 4 - Caratteristiche, modularità e finiture

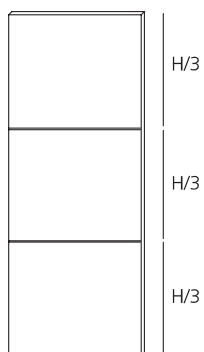

Anta Scorrevole MAX 4

Anta spessore mm 40 in tamburato superleggero divisa in tre settori con regolatori tendi anta e profilo parapolvere.
Tra i settori è inserito un profilo in alluminio naturale - a richiesta è possibile ordinarlo laccato opaco allo stesso prezzo.

Micro maniglia a pendolo inserita sul bordo anta interna.

Carrelli di scorrimento dotati di fermo ammortizzato in apertura e chiusura.

N.B.: l'anta viene consegnata assemblata salvo diverse indicazioni in fase d'ordine.

Finiture previste anta MAX 4

Essenze nostro campionario impiallacciato orizzontale

Laccato opaco

LARGHEZZA

□ Moduli con struttura P. cm 58,6

■ Moduli con struttura P. cm 42,6

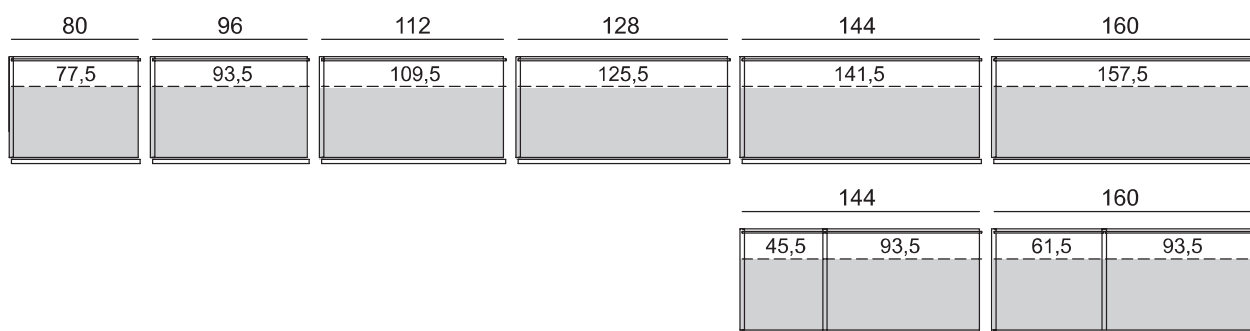

ALTEZZA

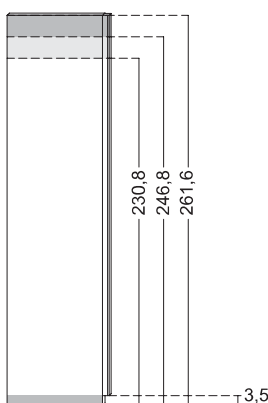

PROFONDITÀ

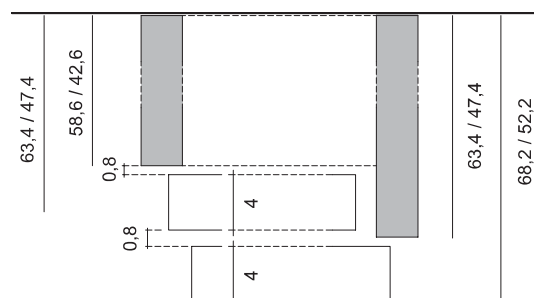

Riduzioni struttura

RIDUZIONE in LARGHEZZA

Il prezzo della riduzione è comprensivo dei tagli:

- Coperchio
- Base
- 1 ripiano
- Schienale

- Anta

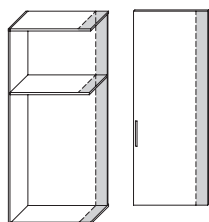

RIDUZIONE in PROFONDITÀ

Il prezzo della riduzione è comprensivo dei tagli e foratura supplementare:

- Coperchio
- Base
- 1 ripiano
- 1 fianco

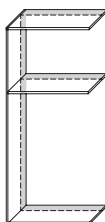

RIDUZIONE in ALTEZZA

Il prezzo della riduzione è comprensivo dei tagli:

- Fianco
- Schienale

- Anta

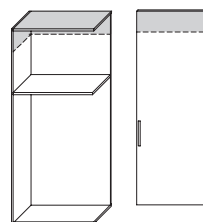

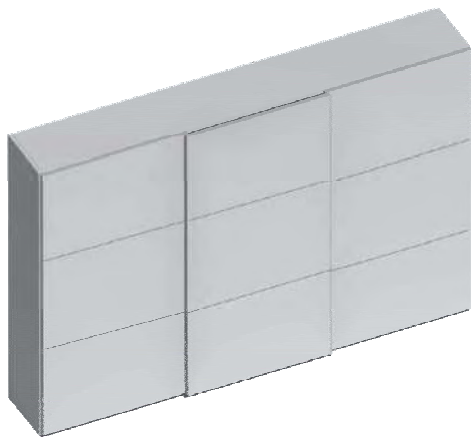

Anta scorrevole MAX 4 - Composizioni





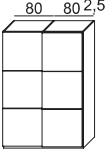
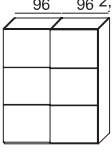
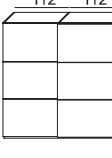
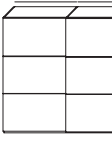

- Armadi P. cm 42,6 stesso prezzo
- Prezzi comprensivi di finitura fianchi come anta
- Incluso un ripiano strutturale Sp. cm 4 a modulo

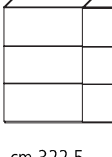
N.B.: per ante composte Essenza/Laccato considerare prezzo Essenza

2 ANTE

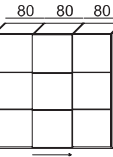
	H.	Codice	Essenza 1	Essenza 2	Laccato Opaco
 <p>L. cm 162,5</p>	230,8	CS3A07			
	246,8	CS4A07			
	261,6	CS6A07			
 <p>L. cm 194,5</p>	230,8	CS3B07			
	246,8	CS4B07			
	261,6	CS6B07			
 <p>L. cm 226,5</p>	230,8	CS3C07			
	246,8	CS4C07			
	261,6	CS6C07			
 <p>L. cm 258,5</p>	230,8	CS3D07			
	246,8	CS4D07			
	261,6	CS6D07			
 <p>L. cm 290,5</p>	230,8	CS3E07			
	246,8	CS4E07			
	261,6	CS6E07			
 <p>L. cm 322,5</p>	230,8	CS3F07			
	246,8	CS4F07			
	261,6	CS6F07			

3 ANTE

	H.	Codice	Essenza 1	Essenza 2	Laccato Opaco
 <p>L. cm 242,5</p>	230,8	CS3G07			
	246,8	CS4G07			
	261,6	CS6G07			
 <p>L. cm 290,5</p>	230,8	CS3H07			
	246,8	CS4H07			
	261,6	CS6H07			
 <p>L. cm 338,5</p>	230,8	CS3L07			
	246,8	CS4L07			
	261,6	CS6L07			
 <p>L. cm 386,5</p>	230,8	CS3M07			
	246,8	CS4M07			
	261,6	CS6M07			

Moduli armadio anta scorrevole MAX 4

N.B.: per ante composte Essenza/Laccato considerare prezzo essenza.

Il prezzo del modulo comprende:

- 1 fianco struttura Sp. cm 2,5
- 1 ripiano interno Sp. cm 4

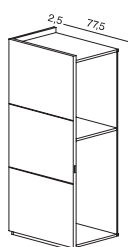

L. cm 80

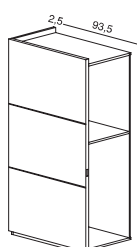

L. cm 96

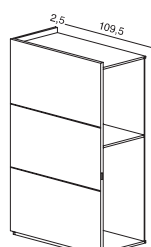

L. cm 112

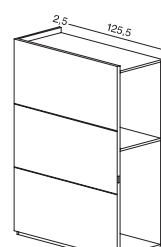

L. cm 128

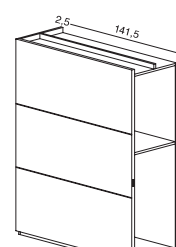

L. cm 144

H. 230,8	Codice	S3807	S3907	S3207	S3107	S3147C
Essenza 1						
Essenza 2						
Laccato opaco						

H. 246,8		S4807	S4907	S4207	S4107	S4147C
Essenza 1						
Essenza 2						
Laccato opaco						

H. 261,6		S6807	S6907	S6207	S6107	S6147C
Essenza 1						
Essenza 2						
Laccato opaco						

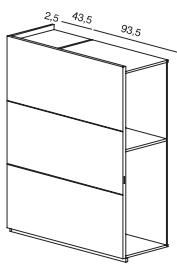

L. cm 144

S3147

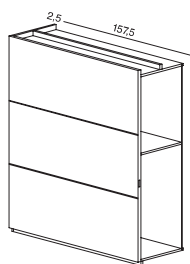

L. cm 160

S3167C

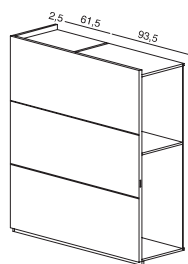

L. cm 160

S3167

Fianco terminale
in melaminico

Supplemento
finitura fianchi
esterni (cad.)



Sp. cm 2,5

S31



FF31

CASSETTIERE interne 4 cassetti
con guide ammortizzate

Per estrazione totale aggiungere
per cassetto



- L. cm 45,5
- L. cm 61,5
- L. cm 77,5
- L. cm 93,5
- L. cm 109,5
- L. cm 125,5

S4147

S4167C

S4167

S46

FF46

Ripiani interni



Sp. 2,5 | Sp. 4

- L. 45,5
- L. 61,5
- L. 77,5
- L. 93,5
- L. 109,5
- L. 125,5
- L. 141,5
- L. 157,5

S6147

S6167C

S6167

S62

FF62

Tubi appendiabiti alluminio



- L. 45,5
- L. 61,5
- L. 77,5
- L. 93,5
- L. 109,5
- L. 125,5
- L. 141,5
- L. 157,5

Attrezzatura interna armadi

RIPIANI - Melaminico

Sp. 2,5 cm - P. 53,5 / 37,5

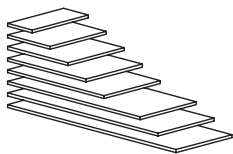

Larghezza cm	29,5 cm	45,5 cm	51,5 cm	61,5 cm	77,5 cm	93,5 cm	109,5 cm	125,5 cm	141,5 cm	157,5 cm
Codice	R29	R45	R51	R61	R77	R93	R109	R125	R141	R157
	Melaminico									

RIPIANI - Melaminico

Sp. 4 cm - P. 53,5 / 37,5

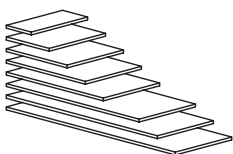

Larghezza cm	29,5 cm	45,5 cm	51,5 cm	61,5 cm	77,5 cm	93,5 cm	109,5 cm	125,5 cm	141,5 cm	157,5 cm
Codice	RH29	RH45	RH51	RH61	RH77	RH93	RH109	RH125	RH141	RH157
	Melaminico									

RIPIANI - Essenza

Sp.4 cm - P. 53,5 / 37,5

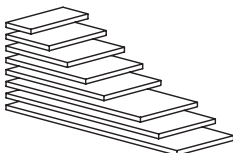

Larghezza cm	29,5 cm	45,5 cm	51,5 cm	61,5 cm	77,5 cm	93,5 cm	109,5 cm	125,5 cm	141,5 cm	157,5 cm
Codice	RE29	RE45	RE51	RE61	RE77	RE93	RE109	RE125	RE141	RE157
	Essenza 1									
	Essenza 2									

RIPIANO ANGOLARE - Melaminico

Sp. 2,5/4 cm - P. 53,5

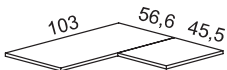

Spessore	2,5 cm	4 cm
Codice	R1	RH1
	Melaminico	

RIPIANO ANGOLARE - Essenza

Sp.4 cm - P. 53,5

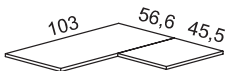

Spessore	4 cm
Codice	RE1
	Essenza 1
	Essenza 2

Attrezzatura interna armadi

RIPIANO TERMINALE - Melaminico

Sp. 2,5/4 cm - P. 53,5 / 37,5

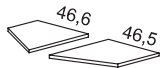

Spessore	2,5 cm	4 cm
Codice	RT1	RTH1
Melaminico		

RIPIANO TERMINALE - Essenza

Sp. 4 cm - P. 53,5 / 37,5

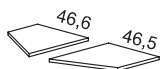

Spessore	4 cm
Codice	RTE1
Essenza 1	
Essenza 2	

RIPIANI ESTRAIBILI - Melaminico

Sp. cm. 2,5 con frontalino H. cm 4 - P. 53,5



	L. 45,5 cm	L. 61,5 cm	L. 77,5 cm	L. 93,5 cm	L. 125,5 cm
Codice	RX45	RX61	RX77	RX93	RX125
Melaminico					

FIANCHI DIVISORI INTERNI - Melaminico

Sp. cm. 2,5 - P. 53,5 / 37,5

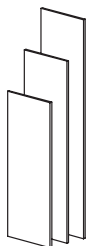

	128,5 cm	160,5 cm	192,5 cm
Codice	FD12	FD16	FD19

SPECCHIO INTERNO

da applicare su anta battente all'interno



	170 x 31,5 cm
Codice	S01

Attrezzatura interna armadi

BARRA APPENDIABILI per P. 58,6

A sezione rettangolare in alluminio verniciato
cemento opaco

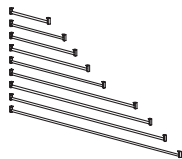

Larghezza cm	29,5 cm	45,5 cm	51,5 cm	61,5 cm	77,5 cm	93,5 cm	109,5 cm	125,5 cm	141,5 cm	157,5 cm
Codice	A29	A45	A51	A61	A77	A93	A109	A125	A141	A157
cemento opaco										

BARRA APPENDIABILI PER ANGOLARE per P. 58,6

A sezione rettangolare in alluminio verniciato
cemento opaco



Codice	A103
cemento opaco	

SERVETTO per P. 58,6

Verniciato grigio alluminio



Codice	da 45 a 60 cm	da 60 a 77 cm	da 93 a 125,5 cm
	S45	S60	S80
Grigio alluminio			

TIRETTO APPENDIABITI

Per ripiano interno

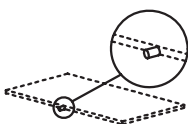

Codice	PG
Cromato	

PORTABITI ESTRAIBILE per P. 58,6



Codice	EG050
Cromato	

Attrezzatura interna armadi

PORTACRAVATTE / PORTACINTURE per P. 58,6

In alluminio fissaggio sul fianco



Codice **EG009**

Alluminio

PORTAPANTALONI ESTRAIBILE per P. 58,6

cm 46 X 20 - fissaggio sul fianco



Codice **EG007**

PORTASCARPE ESTENSIBILE per P. 58,6

cm 46/70 - fissaggio sul fianco

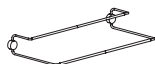

Codice **EG020**

GRUCCIA APPENDIABITI per P. 58,6

Faggio naturale

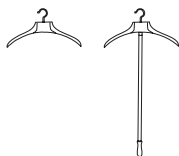

Codice

senza bastone

GR

con bastone

GRB

Faggio naturale

Attrezzatura interna armadi

PORTAPANTALONI ESTRAIBILE per P. 58,6



	per vano cm 77,5	per vano cm 93,5
Codice	PE1	PE2

PORTACINTURE / PORTACRAVATTE ESTRAIBILE per P. 58,6

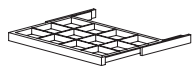

	per vano cm 77,5	per vano cm 93,5
Codice	PE1C	PE2C

RIPIANO CON VASSOIO ESTRAIBILE per P. 58,6

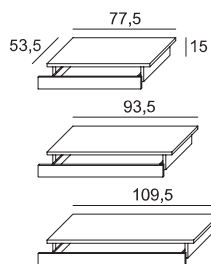

	per vano cm 77,5	per vano cm 93,5	per vano cm 109,5
Codice	RVE77	RVE93	RVE109
Melaminico			

RIPIANO CON VASSOIO ESTRAIBILE TOP VETRO TRASPARENTE per P. 58,6

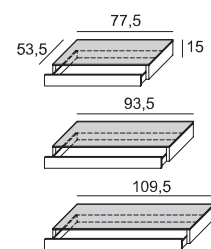

	per vano cm 77,5	per vano cm 93,5	per vano cm 109,5
Codice	RVEC77	RVEC93	RVEC109
Melaminico			

DIVISORIO PORTAOGGETTI PER VASSOI ESTRAIBILI

Finitura Compact lavagna

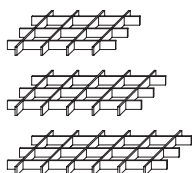

	per vano cm 77,5	per vano cm 93,5	per vano cm 109,5
Codice	DP77	DP93	DP109

ELETRIFICAZIONE INTERNA ARMADI

LUCE LED ORIZZONTALE

Sezione mm 11 x 11 - 4000k

Incassata a filo nel ripiano o nel cappello e dotata di accensione mediante sensore di presenza.

Prezzo escluso alimentatore.

Alimentatori

Potenza Watt	35	60
Codice	TRAS35	TRAS60

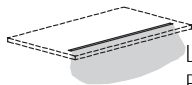

Lunghezza cm	29,5	45,5	53,5	61,5	77,5	93,5	109,5	125,5	141,5	157,5
Potenza Watt	3	5	5,5	6	8	10	11	13	14	16
Codice	L29	L45	L53	L61	L77	L93	L109	L125	L141	L157

LUCE LED ORIZZONTALE PER ANGOLARE

Sezione mm 11 x 11 - 4000k

Incassata a filo nel ripiano o nel cappello e dotata di accensione mediante sensore.

Prezzo escluso alimentatore.

Alimentatori

Potenza Watt	35	60
Codice	TRAS35	TRAS60

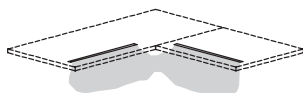

Per angolo da cm	103x104
Potenza Watt	12
Codice	LANG

LUCE LED VERTICALE PER FIANCHI

Sezione mm 11 x 11 - 4000k

Incassata a filo nel fianco dotata di accensione mediante sensore di presenza.

Prezzo escluso alimentatore.

Alimentatori

Potenza Watt	35	60
Codice	TRAS35	TRAS60

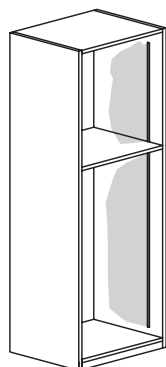

Altezza cm	230,8	246,8	261,6	294,8
Potenza Watt	23	25	27	30
Codice	L230	L246	L261	L294

LAMPADA DA INCASSO NEL COPERCHIO A LED

Con sensore di accensione



Codice	LL
---------------	-----------

BOTTOLA PER ISPEZIONE ALIMENTATORI

Posizionabile su cappello, base o fianco



	cm 20x20
Codice	BTA

LAVORAZIONI SU MISURA - Riduzioni in altezza

TAGLIO IN ALTEZZA MODULI ANTE BATTENTI

Modifica non possibile su ante mod. LINEAR

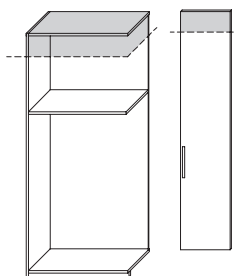

COSTO TAGLIO A COMPONENTE

- Fianco
- Schienale
- Anta

- Taglio modulo ad 1 anta

- Taglio modulo 2 ante

TAGLIO IN ALTEZZA MODULI ANTE BATTENTI - ANTA TAGLIO INCLINATO PER MANSARDA

Modifica non possibile su ante mod. LINEAR

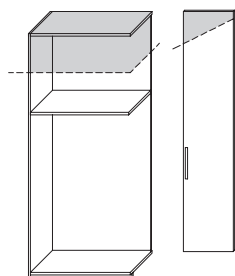
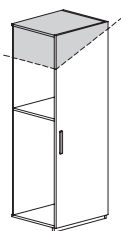

COSTO TAGLIO A COMPONENTE

- Fianco
- Schienale
- Anta

- Taglio modulo ad 1 anta

TAGLIO IN ALTEZZA MODULI ANTE SCORREVOLI

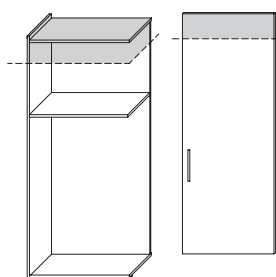
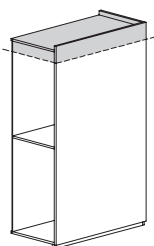

COSTO TAGLIO A COMPONENTE

- Fianco
- Schienale
- Anta

- Taglio modulo e 1 anta

TAGLIO IN LARGHEZZA MODULI ANTE BATTENTI

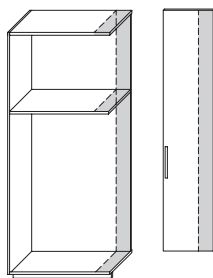
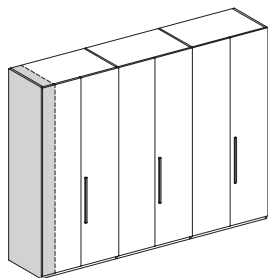

COSTO TAGLIO A COMPONENTE

- Cappello
- Base
- Ripiano
- Schienale
- Anta

- Taglio modulo ad 1 anta

- Taglio modulo 2 ante

TAGLIO IN LARGHEZZA MODULI ANTE SCORREVOLI

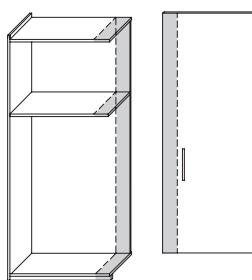
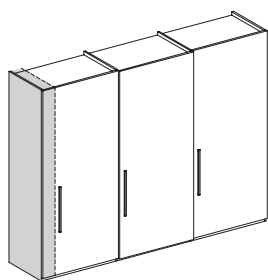

COSTO TAGLIO A COMPONENTE

- Cappello
- Base
- Ripiano
- Schienale
- Anta

- Taglio modulo anta scorrevole

TAGLIO IN LARGHEZZA MODULI PONTE ANTA PIANA

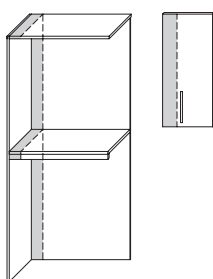
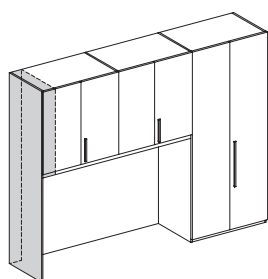

COSTO TAGLIO A COMPONENTE

- Cappello
- Base
- Ripiano
- Schienale
- Telaio ponte rivestito
- Anta

- Taglio modulo e 1 anta
ecluso rip. int.

TAGLIO IN PROFONDITÀ MODULI ANTE BATTENTI - SCORREVOLI

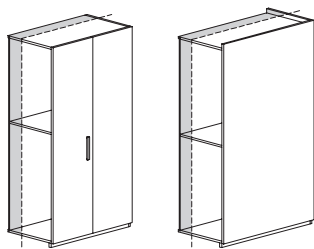

- Taglio modulo
con 1 fianco

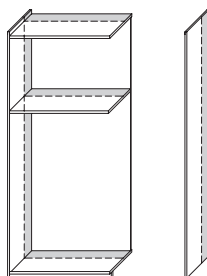

COSTO TAGLIO A COMPONENTE

- Cappello
- Base
- Ripiano
- Fianco

TAGLIO IN PROFONDITÀ MODULI PONTE ANTA PIANA

(esempio su ponte 4 ante con fianco centrale)

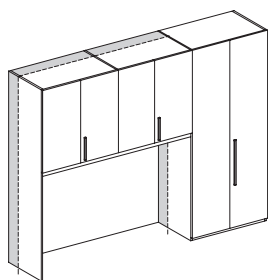

- Taglio modulo ponte con 1 fianco centrale
esclusi ripiani interni

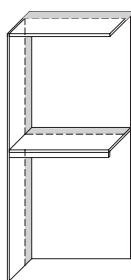

COSTO TAGLIO A COMPONENTE

- Cappello
- Base
- Ripiano
- Fianco centrale
- Telaio ponte rivestito

RISEGHE PER PILASTRI

Modifica alla scocca su moduli ante battenti/scorrevoli.
Prezzo comprensivo di tagli e tamponamenti incluso
1 taglio risega al ripiano strutturale

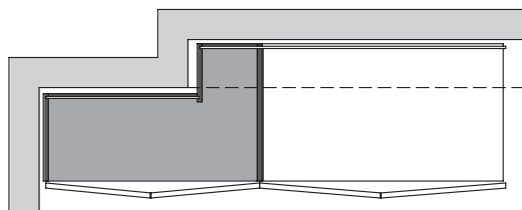

- Risega modulo

- Risega per ogni ripiano aggiunto Euro 37

TAMPONAMENTO LATERALE APRIBILE AD ANTA BATTENTE MOD. PIANA

Su misura in larghezza e in altezza
 Larghezza minima cm 15
 Larghezza massima cm 47,7
 Altezza massima cm 291

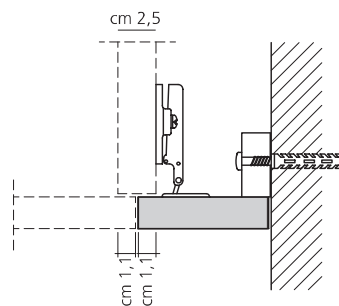
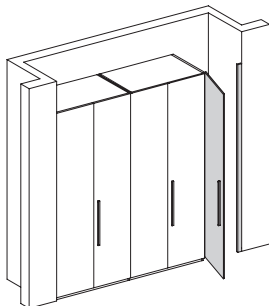

Tipo Anta	Codice	Essenza 1	Essenza 2	Laccato Opaco
PIANA	FTA			

FASCE TAMPONAMENTO LATERALI E SUPERIORI Sp. cm 2,5

Per armadi anta battente e scorrevoli
 Utilizzabili a filo fianco "A" (battente e scorrevole) o a filo anta "B" (solo battente)
 Larghezza massima cm 300

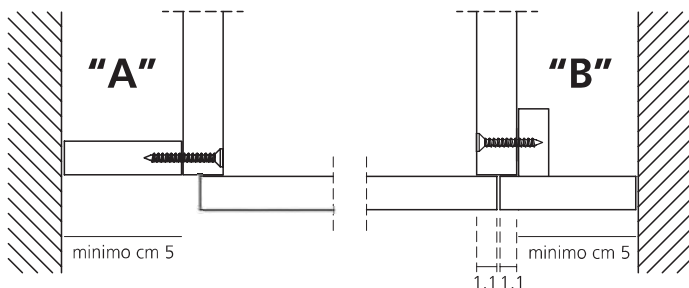

	Prezzo al Mtl.	Codice	Essenza 1	Essenza 2	Laccato Opaco
A	da cm 5 a 15	FT1A			
	da cm 15 a 25	FT2A			
B	da cm 5 a 15	FT1B			
	da cm 15 a 25	FT2B			

FERRAMENTA MONTAGGIO IN NICCHIA

Foratura speciale e ferramenta per il montaggio in nicchia dei moduli.
 Tolleranza laterale per montaggio cm 1

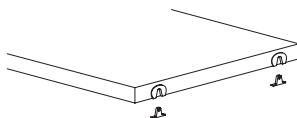

MAGGIORAZIONE PER PREDISPOZIONE montaggio in nicchia - a modulo

Codice
 MNA

CERNIERE 180 GRADI

Cerniere ad apertura 180 gradi per tutte le ante battenti in legno
 Di serie sui moduli ad angolo
 Non utilizzabili per terminali



MAGGIORAZIONE PER ANTA con cerniere 180 gradi

Codice
 C180

ELEMENTI DI FINITURA

- Pannelli a misura spessore 20 mm finitura 1 lato
- Completi di attaccaglie per il fissaggio a muro
- 1 lato non deve superare cm 120
- Minimo fatturabile Mq. 0,50



Codice _____ **PT** prezzo al Mq.
Melaminico Bianco
Essenza 1
Essenza 2
Laccato Opaco

- Specchi per pannellature spessore mm 5
- Minimo fatturabile Mq. 0,50

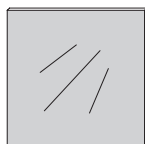

Codice _____ **SPE5** prezzo al Mq.

PANNELLI PER MODULI BIFRONTE Sp. mm 25

I pannelli di finitura per moduli bifronte sono applicati sul retro delle composizioni lineari ad anta battente e scorrevole
La suddivisione dei pannelli, salvo diverse specifiche indicate in sede d'ordine, segue la stessa delle ante.

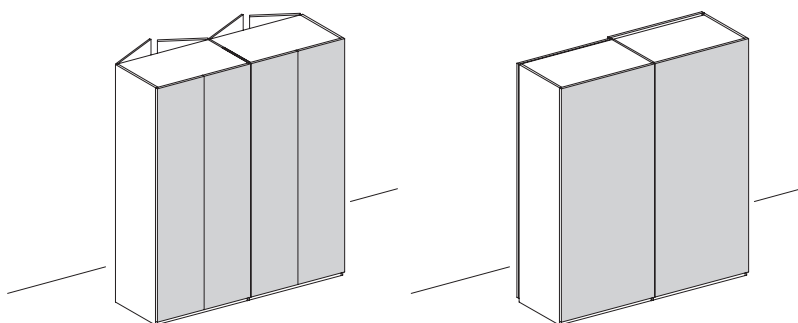

Codice _____ **PT25** prezzo al Mq.
Essenza 1
Essenza 2
Laccato Opaco

CASSETTIERE INTERNE P. cm 49 per moduli P. cm 58,6

FINITURE E CARATTERISTICHE :

Le cassettiere interne sono realizzate nelle finiture in MELAMINICO, ESSENZE E LACCATURE NOSTRO CAMPIONARIO.
I frontali in legno sono disponibili in altezza cm 15,7 ed altezza cm 31,7
I frontali in vetro trasparente a telaio sono disponibili in altezza cm 15,7 con telaio SOLO LACCATO OPACO

I cassetti sono montati su guide a scomparsa con rientro automatico ammortizzato ad estrazione parziale.
Per guide ad estrazione totale aggiungere Euro 27 per ogni cassetto.

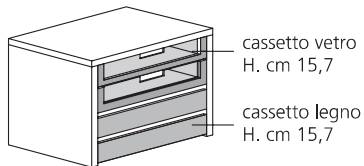
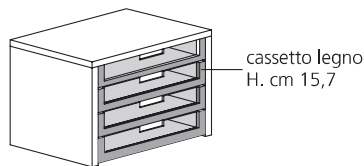
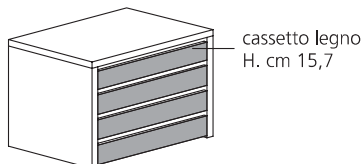
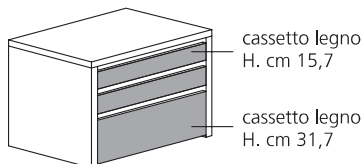

DI SERIE:

Apertura senza maniglia con fuga di cm 2 tra i frontali.

CON SOVRAPPREZZO:

Apertura con maniglia sul filo superiore del frontale color cemento opaco.

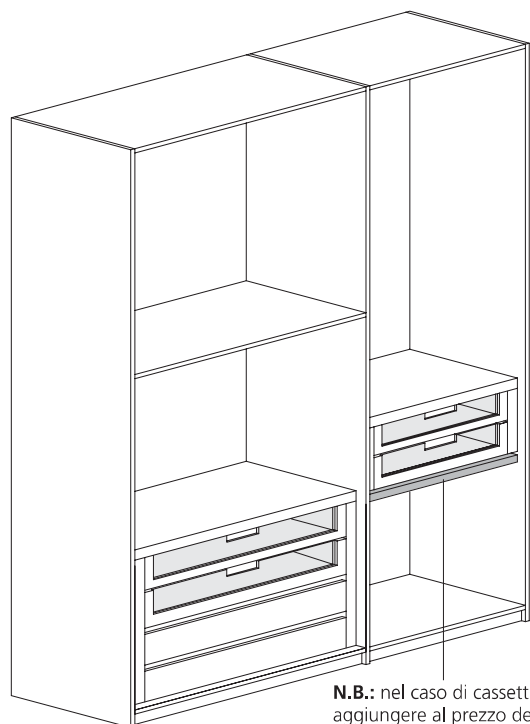

N.B.: nel caso di cassettiere sospese aggiungere al prezzo della cassettera il prezzo di un ripiano Sp. cm 4

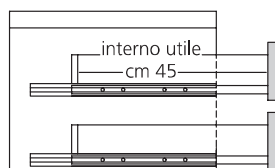

Altezza struttura cassetto cm 12 (per frontale H. cm 15,7)

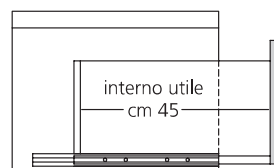

Altezza struttura cassetto cm 24 (per frontale H. cm 31,7)

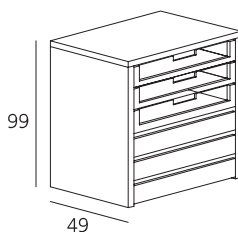
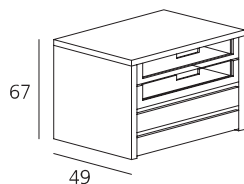
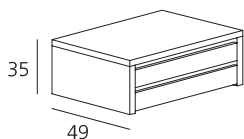

CASSETTIERE INTERNE per vano L. cm 45,5

Altezza cm 32,5 + top

1 cassetto legno

2 cassetti legno



Largezza

L. cm 45,5

L. cm 45,5

Codice

CM01

CM02

Melaminico

Essenza 1

Essenza 2

Laccato opaco

Supplemento per maniglia su filo cassetto

Altezza cm 64,5 + top

3 cassetti legno

4 cassetti legno



Largezza

L. cm 45,5

L. cm 45,5

Codice

CM03

CM04

Melaminico

Essenza 1

Essenza 2

Laccato opaco

Supplemento per maniglia su filo cassetto

Altezza cm 96,5 + top

5 cassetti legno

6 cassetti legno

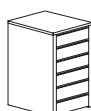
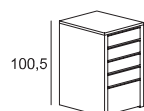

Largezza

L. cm 45,5

L. cm 45,5

Codice

CM05

CM06

Melaminico

Essenza 1

Essenza 2

Laccato opaco

Supplemento per maniglia su filo cassetto

CASSETTIERE INTERNE per vano L. cm 53,5

Altezza cm 32,5 + top

1 cassetto legno

2 cassetti legno

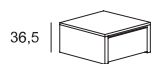

Largezza

L. cm 53,5

L. cm 53,5

Codice

CM1L

CM2L

Melaminico

Essenza 1

Essenza 2

Laccato opaco

Supplemento per maniglia su filo cassetto

Altezza cm 64,5 + top

3 cassetti legno

4 cassetti legno



Largezza

L. cm 53,5

L. cm 53,5

Codice

CM3L

CM4L

Melaminico

Essenza 1

Essenza 2

Laccato opaco

Supplemento per maniglia su filo cassetto

Altezza cm 96,5 + top

5 cassetti legno

6 cassetti legno

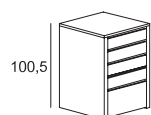

Largezza

L. cm 53,5

L. cm 53,5

Codice

CM5L

CM6L

Melaminico

Essenza 1

Essenza 2

Laccato opaco

Supplemento per maniglia su filo cassetto

CASSETTIERE INTERNE per vano L. cm 61,5

Altezza cm 32,5 + top

1 cassetto legno

2 cassetti legno

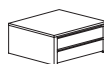

Largezza

L. cm 61,5

L. cm 61,5

Codice

CM07

CM08

Melaminico

Essenza 1

Essenza 2

Laccato opaco

Supplemento per maniglia su filo cassetto

Altezza cm 64,5 + top

3 cassetti legno

4 cassetti legno



Largezza

L. cm 61,5

L. cm 61,5

Codice

CM09

CM10

Melaminico

Essenza 1

Essenza 2

Laccato opaco

Supplemento per maniglia su filo cassetto

Altezza cm 96,5 + top

5 cassetti legno

6 cassetti legno

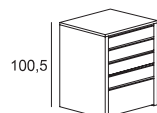

Largezza

L. cm 61,5

L. cm 61,5

Codice

CM11

CM12

Melaminico

Essenza 1

Essenza 2

Laccato opaco

Supplemento per maniglia su filo cassetto

CASSETTIERE INTERNE per vano L. cm 77,5

Altezza cm 32,5 + top

1 cassetto legno

2 cassetti legno

2 cassetti vetro

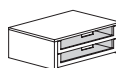
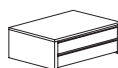
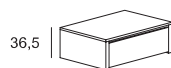

Largezza

L. cm 77,5

L. cm 77,5

L. cm 77,5

Codice

CM13

CM14

CM15

Melaminico

Essenza 1

Essenza 2

Laccato opaco

Supplemento per maniglia su filo cassetto

Altezza cm 64,5 + top

3 cassetti legno

4 cassetti legno

4 cassetti vetro

2 cassetti vetro
2 cassetti legno

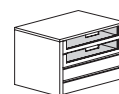
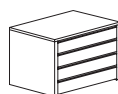

Largezza

L. cm 77,5

L. cm 77,5

L. cm 77,5

L. cm 77,5

Codice

CM16

CM18

CM19

CM20

Melaminico

Essenza 1

Essenza 2

Laccato opaco

Supplemento per maniglia su filo cassetto

Altezza cm 96,5 + top

5 cassetti legno

6 cassetti legno

6 cassetti vetro

2 cassetti vetro
4 cassetti legno

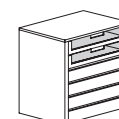
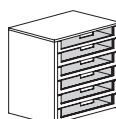
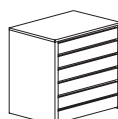
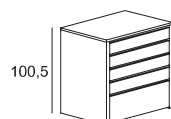

Largezza

L. cm 77,5

L. cm 77,5

L. cm 77,5

L. cm 77,5

Codice

CM21

CM22

CM23

CM24

Melaminico

Essenza 1

Essenza 2

Laccato opaco

Supplemento per maniglia su filo cassetto

CASSETTIERE INTERNE per vano L. cm 93,5

Altezza cm 32,5 + top

1 cassetto legno

2 cassetti legno

2 cassetti vetro

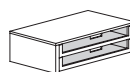

Largezza

L. cm 93,5

L. cm 93,5

L. cm 93,5

Codice

CM25

CM26

CM27

Melaminico

Essenza 1

Essenza 2

Laccato opaco

Supplemento per maniglia su filo cassetto

Altezza cm 64,5 + top

3 cassetti legno

4 cassetti legno

4 cassetti vetro

2 cassetti vetro
2 cassetti legno

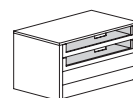
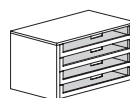
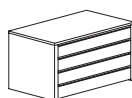
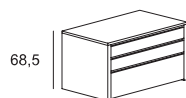

Largezza

L. cm 93,5

L. cm 93,5

L. cm 93,5

L. cm 93,5

Codice

CM28

CM29

CM30

CM31

Melaminico

Essenza 1

Essenza 2

Laccato opaco

Supplemento per maniglia su filo cassetto

Altezza cm 96,5 + top

5 cassetti legno

6 cassetti legno

6 cassetti vetro

2 cassetti vetro
4 cassetti legno

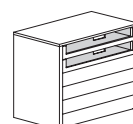
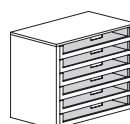
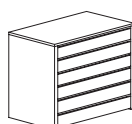
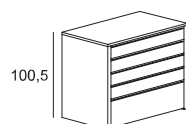

Largezza

L. cm 93,5

L. cm 93,5

L. cm 93,5

L. cm 93,5

Codice

CM32

CM33

CM34

CM35

Melaminico

Essenza 1

Essenza 2

Laccato opaco

Supplemento per maniglia su filo cassetto

CASSETTIERE INTERNE per vano L. cm 109,5

Altezza cm 32,5 + top

1 cassetto legno

2 cassetti legno

4 cassetti legno

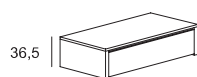

Largezza

L. cm 109,5

L. cm 109,5

L. cm 109,5

Codice

CM25L

CM26L

CM27L

Melaminico

Essenza 1

Essenza 2

Laccato opaco

Supplemento per maniglia su filo cassetto

Altezza cm 64,5 + top

3 cassetti legno

4 cassetti legno

8 cassetti legno

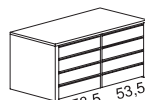
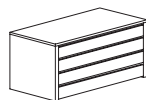
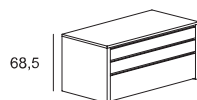

Largezza

L. cm 109,5

L. cm 109,5

L. cm 109,5

Codice

CM28L

CM29L

CM30L

Melaminico

Essenza 1

Essenza 2

Laccato opaco

Supplemento per maniglia su filo cassetto

Altezza cm 96,5 + top

5 cassetti legno

6 cassetti legno

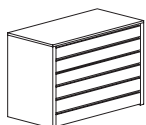
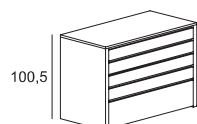

Largezza

L. cm 109,5

L. cm 109,5

Codice

CM32L

CM33L

Melaminico

Essenza 1

Essenza 2

Laccato opaco

Supplemento per maniglia su filo cassetto

CASSETTIERE INTERNE per vano L. cm 125,5

Altezza cm 32,5 + top

1 cassetto legno

2 cassetti legno

4 cassetti legno

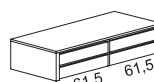
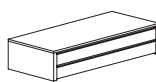
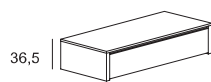

Largezza

L. cm 125,5

L. cm 125,5

L. cm 125,5

Codice

CM36

CM37

CM38

Melaminico

Essenza 1

Essenza 2

Laccato opaco

Supplemento per maniglia su filo cassetto

Altezza cm 64,5 + top

3 cassetti legno

4 cassetti legno

8 cassetti legno

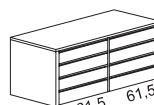
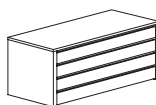
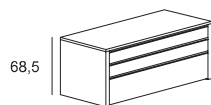

Largezza

L. cm 125,5

L. cm 125,5

L. cm 125,5

Codice

CM39

CM40

CM41

Melaminico

Essenza 1

Essenza 2

Laccato opaco

Supplemento per maniglia su filo cassetto

Altezza cm 96,5 + top

5 cassetti legno

6 cassetti legno

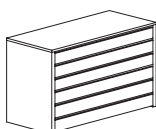
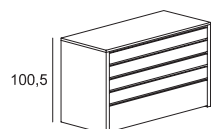

Largezza

L. cm 125,5

L. cm 125,5

Codice

CM42

CM43

Melaminico

Essenza 1

Essenza 2

Laccato opaco

Supplemento per maniglia su filo cassetto

CASSETTIERE INTERNE per vano L. cm 141,5

Altezza cm 32,5 + top

1 cassetto legno

2 cassetti legno

2 cassetti legno

4 cassetti legno

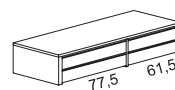
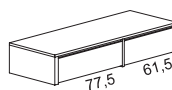
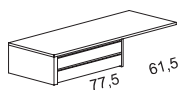
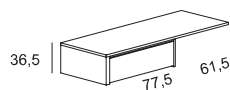

Largezza

L. cm 141,5

L. cm 141,5

L. cm 141,5

L. cm 141,5

Codice

CM44

CM45

CM46

CM47

Melaminico

Essenza 1

Essenza 2

Laccato opaco

Supplemento per maniglia su filo cassetto

Altezza cm 64,5 + top

3 cassetti legno

4 cassetti legno

4 cassetti legno

8 cassetti legno

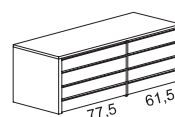
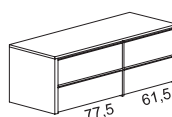
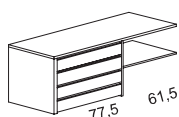
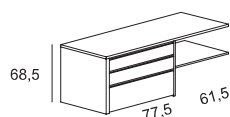

Largezza

L. cm 141,5

L. cm 141,5

L. cm 141,5

L. cm 141,5

Codice

CM48

CM49

CM50

CM51

Melaminico

Essenza 1

Essenza 2

Laccato opaco

Supplemento per maniglia su filo cassetto

Altezza cm 96,5 + top

5 cassetti legno

6 cassetti legno

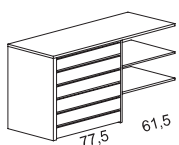
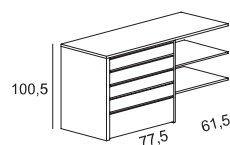

Largezza

L. cm 141,5

L. cm 141,5

Codice

CM52

CM53

Melaminico

Essenza 1

Essenza 2

Laccato opaco

Supplemento per maniglia su filo cassetto

CASSETTIERE INTERNE per vano L. cm 157,5

Altezza cm 32,5 + top

1 cassetto legno

2 cassetti legno

2 cassetti legno

4 cassetti legno

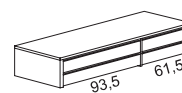
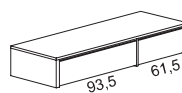
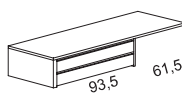
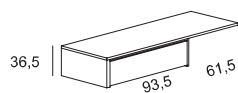

Largezza

L. cm 157,5

L. cm 157,5

L. cm 157,5

L. cm 157,5

Codice

CM54

CM55

CM56

CM57

Melaminico

Essenza 1

Essenza 2

Laccato opaco

Supplemento per maniglia su filo cassetto

Altezza cm 64,5 + top

3 cassetti legno

4 cassetti legno

4 cassetti legno

8 cassetti legno

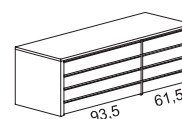
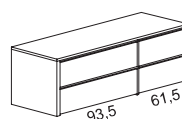
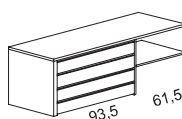
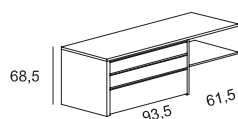

Largezza

L. cm 157,5

L. cm 157,5

L. cm 157,5

L. cm 157,5

Codice

CM58

CM59

CM60

CM61

Melaminico

Essenza 1

Essenza 2

Laccato opaco

Supplemento per maniglia su filo cassetto

Altezza cm 96,5 + top

5 cassetti legno

6 cassetti legno

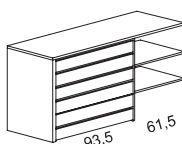
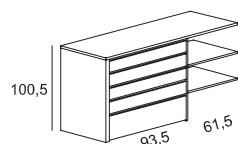

Largezza

L. cm 157,5

L. cm 157,5

Codice

CM62

CM63

Melaminico

Essenza 1

Essenza 2

Laccato opaco

Supplemento per maniglia su filo cassetto

ELEMENTI PASSAGGIO PORTA E PONTE ARMATO

CARATTERISTICHE :

I moduli passaggio porta e ponte armato si abbinano ai moduli ad anta battente o ad anta scorrevole interna. Sono posizionati tra fianchi di armadi a terra ed hanno ante Mod. PIANA in spessore cm 2,5 sporgenti cm 1,5 sotto per permettere l'apertura senza maniglia. Il basamento dell'elemento passaggio porta è rifinito come le ante.

I moduli ponte armato sono dotati, a sostegno del basamento, di un robusto telaio in acciaio rivestito da un pannello e da un frontalino H. cm 7 della medesima finitura delle ante.

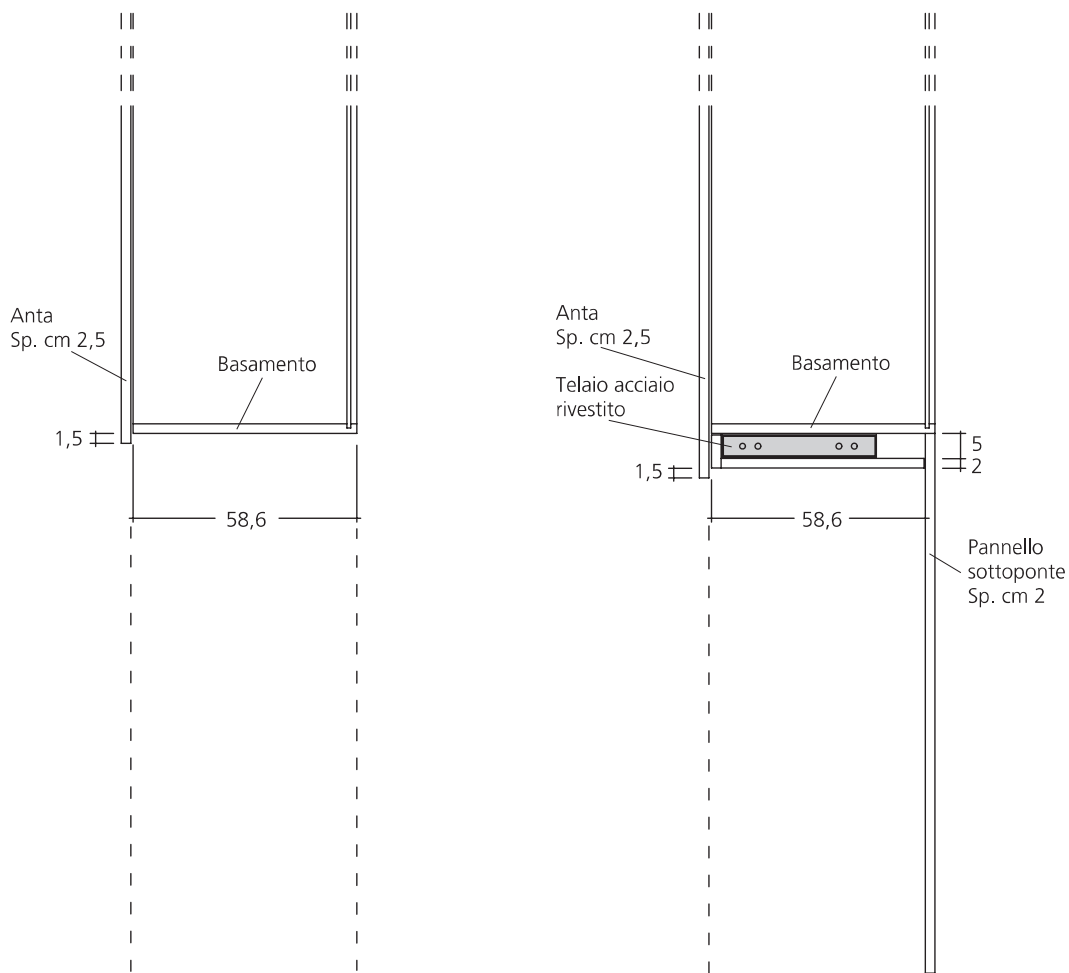

Elementi ponte

- PANNELLI SOTTOPONTE Sp. cm 2 (prezzo al MQ.)

- 1 lato non deve superare cm 120
- Minimo fatturabile Mq. 0,50

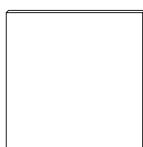

Codice	PT	prezzo al Mq.
Essenza 1		
Essenza 2		
Laccato Opaco		

- PER EVENTUALI MENSOLE, SCRITTOI E ALTRE ATTREZZATURE ADATTABILI ALL'USO SOTTO PONTE CONSULTARE IL LISTINO GIORNO.

ELEMENTI PONTE PASSAGGIO PORTA - Struttura P. cm 58,6 - Esclusi fianchi laterali

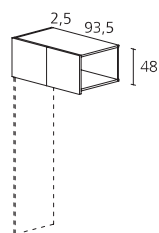

L. cm 93,5

H. cm 48

Codice **P48**

Essenza 1

Essenza 2

Laccato opaco

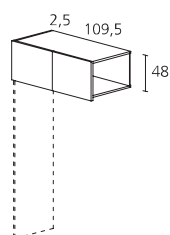

L. cm 109,5

H. cm 48

Codice **P48B**

Essenza 1

Essenza 2

Laccato opaco

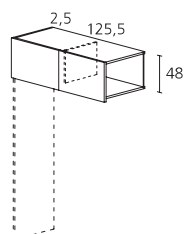

L. cm 125,5

H. cm 48

Codice **P48C**

Essenza 1

Essenza 2

Laccato opaco

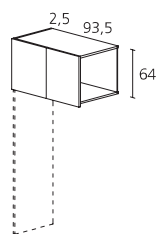

L. cm 93,5

H. cm 64

Codice **P64**

Essenza 1

Essenza 2

Laccato opaco

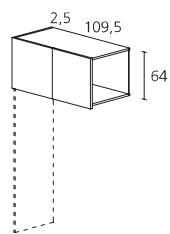

L. cm 109,5

H. cm 64

Codice **P64B**

Essenza 1

Essenza 2

Laccato opaco

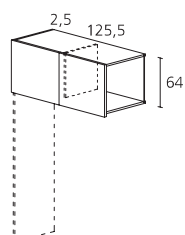

L. cm 125,5

H. cm 64

Codice **P64C**

Essenza 1

Essenza 2

Laccato opaco

ELEMENTI PONTE ARMATO - Struttura P. cm 58,6 - Esclusi fianchi laterali

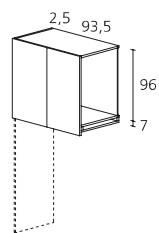

L. cm 93,5

H. cm 96

Codice **P627**

Essenza 1

Essenza 2

Laccato opaco

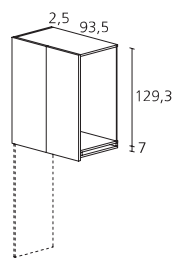

L. cm 93,5

H. cm 129,3

Codice **P639**

Essenza 1

Essenza 2

Laccato opaco

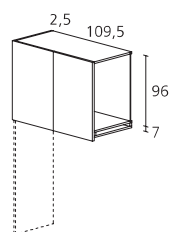

L. cm 109,5

H. cm 96

Codice **P627B**

Essenza 1

Essenza 2

Laccato opaco

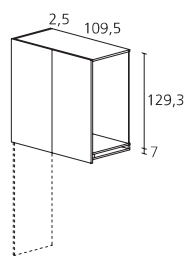

L. cm 109,5

H. cm 129,3

Codice **P639B**

Essenza 1

Essenza 2

Laccato opaco

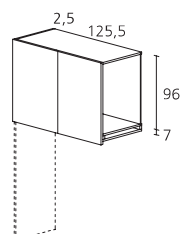

L. cm 125,5

H. cm 96

Codice **P627C**

Essenza 1

Essenza 2

Laccato opaco

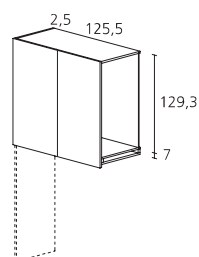

L. cm 125,5

H. cm 129,3

Codice **P639C**

Essenza 1

Essenza 2

Laccato opaco

ELEMENTI PONTE ARMATO - Struttura P. cm 58,6 - Esclusi fianchi laterali

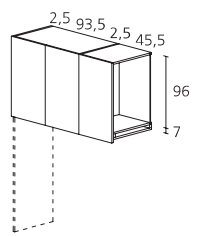
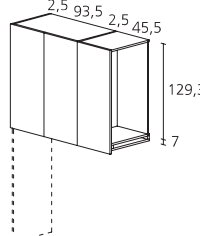
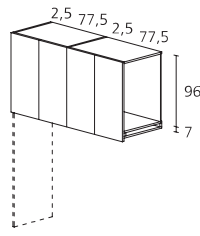
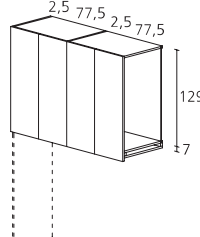
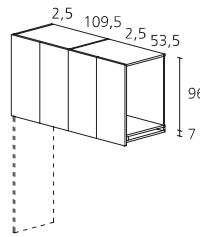
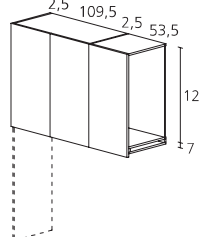
 <p>L. cm 141,5</p>	<p>H. cm 96</p> <p>Codice P628</p> <hr/> <p>Essenza 1</p> <hr/> <p>Essenza 2</p> <hr/> <p>Laccato opaco</p> <hr/>
 <p>L. cm 141,5</p>	<p>H. cm 129,3</p> <p>Codice P640</p> <hr/> <p>Essenza 1</p> <hr/> <p>Essenza 2</p> <hr/> <p>Laccato opaco</p> <hr/>
 <p>L. cm 157,5</p>	<p>H. cm 96</p> <p>Codice P625</p> <hr/> <p>Essenza 1</p> <hr/> <p>Essenza 2</p> <hr/> <p>Laccato opaco</p> <hr/>
 <p>L. cm 157,5</p>	<p>H. cm 129,3</p> <p>Codice P626</p> <hr/> <p>Essenza 1</p> <hr/> <p>Essenza 2</p> <hr/> <p>Laccato opaco</p> <hr/>
 <p>L. cm 165,5</p>	<p>H. cm 96</p> <p>Codice P628B</p> <hr/> <p>Essenza 1</p> <hr/> <p>Essenza 2</p> <hr/> <p>Laccato opaco</p> <hr/>
 <p>L. cm 165,5</p>	<p>H. cm 129,3</p> <p>Codice P640B</p> <hr/> <p>Essenza 1</p> <hr/> <p>Essenza 2</p> <hr/> <p>Laccato opaco</p> <hr/>

ELEMENTI PONTE ARMATO - Struttura P. cm 58,6 - Esclusi fianchi laterali

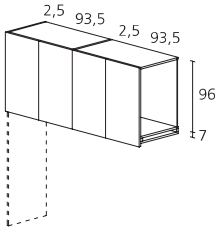
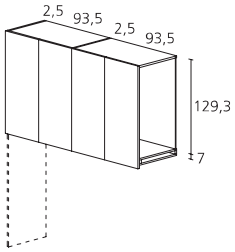
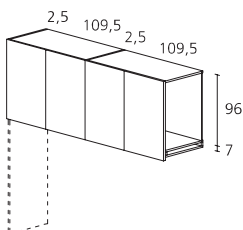
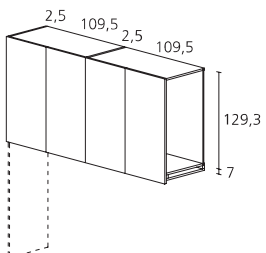
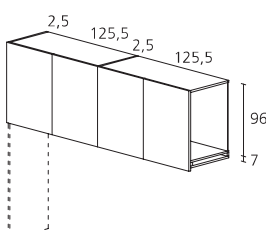
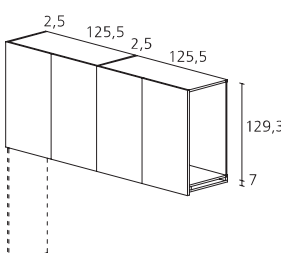
 <p>L. cm 189,5</p>	<p>H. cm 96</p> <p>Codice P661</p> <p>Essenza 1 _____</p> <p>Essenza 2 _____</p> <p>Laccato opaco _____</p>
 <p>L. cm 189,5</p>	<p>H. cm 129,3</p> <p>Codice P667</p> <p>Essenza 1 _____</p> <p>Essenza 2 _____</p> <p>Laccato opaco _____</p>
 <p>L. cm 221,5</p>	<p>H. cm 96</p> <p>Codice P661B</p> <p>Essenza 1 _____</p> <p>Essenza 2 _____</p> <p>Laccato opaco _____</p>
 <p>L. cm 221,5</p>	<p>H. cm 129,3</p> <p>Codice P667B</p> <p>Essenza 1 _____</p> <p>Essenza 2 _____</p> <p>Laccato opaco _____</p>
 <p>L. cm 253,5</p>	<p>H. cm 96</p> <p>Codice P662</p> <p>Essenza 1 _____</p> <p>Essenza 2 _____</p> <p>Laccato opaco _____</p>
 <p>L. cm 253,5</p>	<p>H. cm 129,3</p> <p>Codice P668</p> <p>Essenza 1 _____</p> <p>Essenza 2 _____</p> <p>Laccato opaco _____</p>

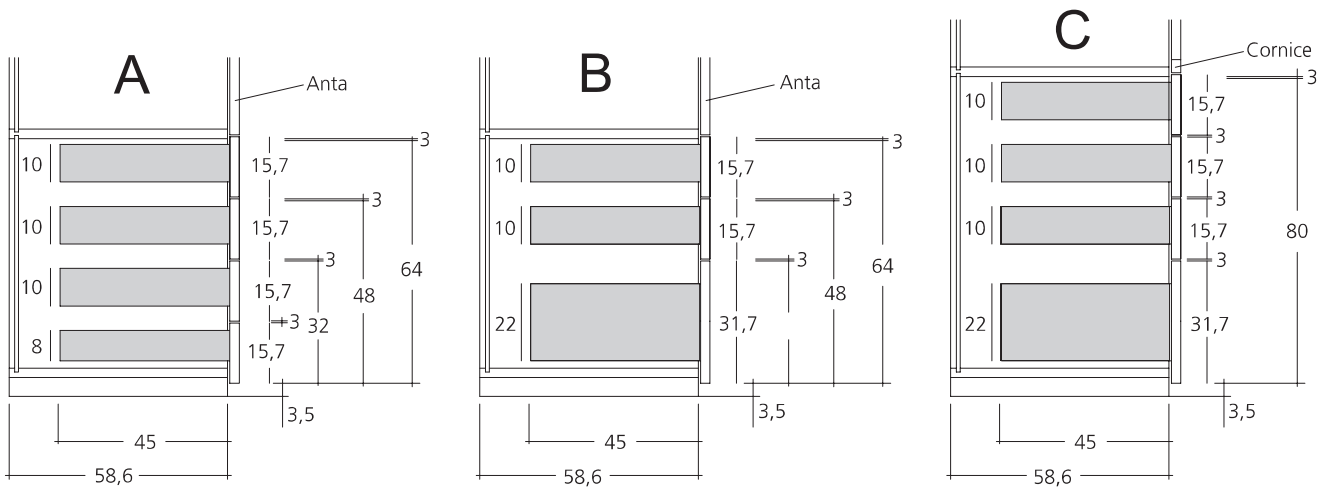
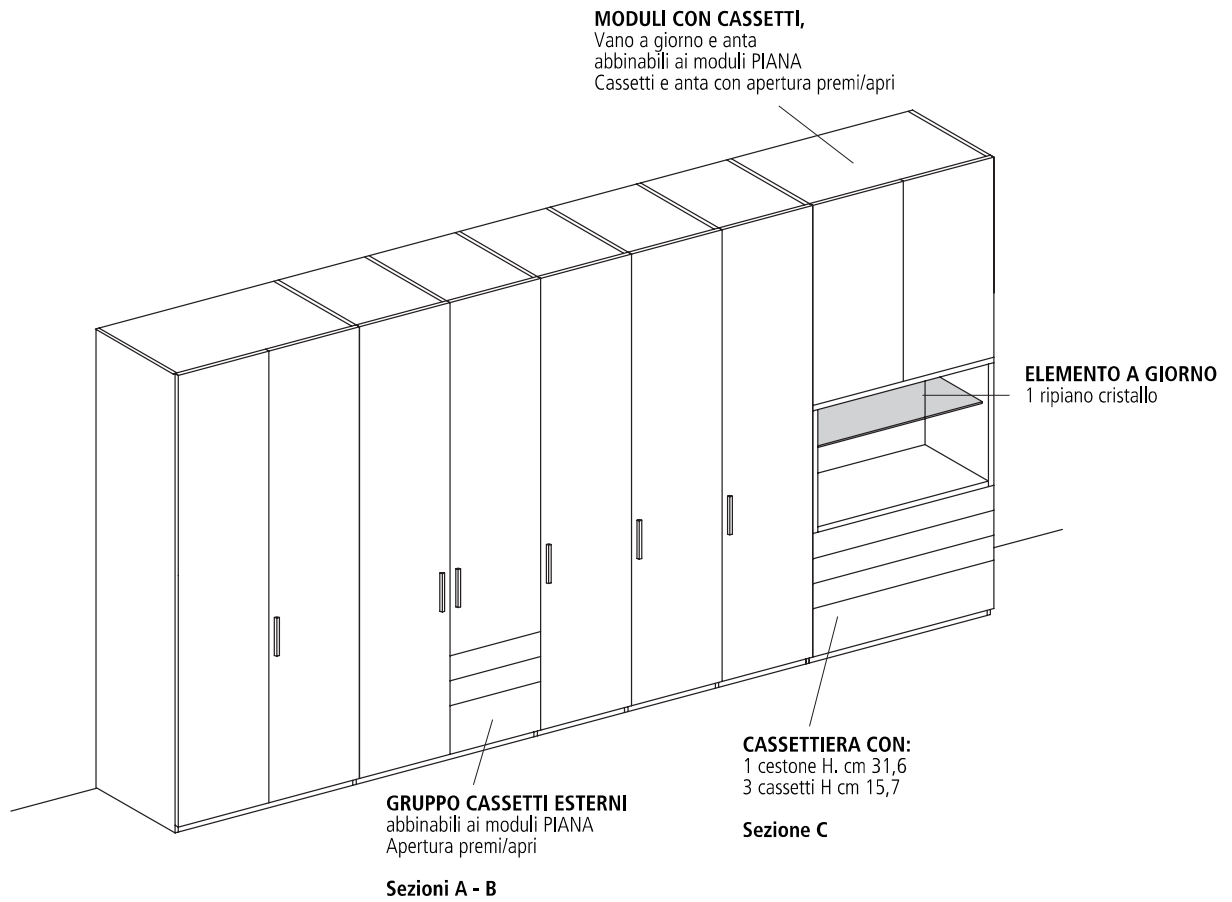

GRUPPO CASSETTI ESTERNI PER MODULI P. cm 58,6 - Apertura premi / apri

GRUPPO INSERIBILE nei moduli anta PIANA

Sommare il costo del gruppo cassette al costo modulo anta.

Il prezzo è comprensivo della riduzione anta in altezza.

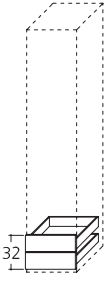
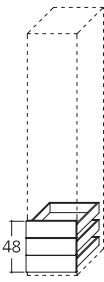
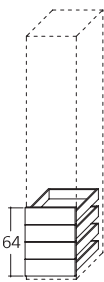
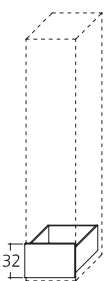
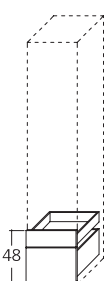
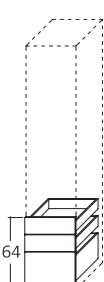
	<table border="1"> <thead> <tr> <th></th> <th>L. cm 48</th> <th>L. cm 56</th> <th>L. cm 64</th> <th>L. cm 80</th> <th>L. cm 96</th> </tr> </thead> <tbody> <tr> <td>Codice</td> <td>2CB48</td> <td>2CB56</td> <td>2CB64</td> <td>2CB80</td> <td>2CB96</td> </tr> <tr> <td>Essenza 1</td> <td colspan="5">_____</td> </tr> <tr> <td>Essenza 2</td> <td colspan="5">_____</td> </tr> <tr> <td>Laccato opaco</td> <td colspan="5">_____</td> </tr> </tbody> </table>		L. cm 48	L. cm 56	L. cm 64	L. cm 80	L. cm 96	Codice	2CB48	2CB56	2CB64	2CB80	2CB96	Essenza 1	_____					Essenza 2	_____					Laccato opaco	_____				
	L. cm 48	L. cm 56	L. cm 64	L. cm 80	L. cm 96																										
Codice	2CB48	2CB56	2CB64	2CB80	2CB96																										
Essenza 1	_____																														
Essenza 2	_____																														
Laccato opaco	_____																														
	<table border="1"> <thead> <tr> <th></th> <th>L. cm 48</th> <th>L. cm 56</th> <th>L. cm 64</th> <th>L. cm 80</th> <th>L. cm 96</th> </tr> </thead> <tbody> <tr> <td>Codice</td> <td>3CB48</td> <td>3CB56</td> <td>3CB64</td> <td>3CB80</td> <td>3CB96</td> </tr> <tr> <td>Essenza 1</td> <td colspan="5">_____</td> </tr> <tr> <td>Essenza 2</td> <td colspan="5">_____</td> </tr> <tr> <td>Laccato opaco</td> <td colspan="5">_____</td> </tr> </tbody> </table>		L. cm 48	L. cm 56	L. cm 64	L. cm 80	L. cm 96	Codice	3CB48	3CB56	3CB64	3CB80	3CB96	Essenza 1	_____					Essenza 2	_____					Laccato opaco	_____				
	L. cm 48	L. cm 56	L. cm 64	L. cm 80	L. cm 96																										
Codice	3CB48	3CB56	3CB64	3CB80	3CB96																										
Essenza 1	_____																														
Essenza 2	_____																														
Laccato opaco	_____																														
	<table border="1"> <thead> <tr> <th></th> <th>L. cm 48</th> <th>L. cm 56</th> <th>L. cm 64</th> <th>L. cm 80</th> <th>L. cm 96</th> </tr> </thead> <tbody> <tr> <td>Codice</td> <td>4CB48</td> <td>4CB56</td> <td>4CB64</td> <td>4CB80</td> <td>4CB96</td> </tr> <tr> <td>Essenza 1</td> <td colspan="5">_____</td> </tr> <tr> <td>Essenza 2</td> <td colspan="5">_____</td> </tr> <tr> <td>Laccato opaco</td> <td colspan="5">_____</td> </tr> </tbody> </table>		L. cm 48	L. cm 56	L. cm 64	L. cm 80	L. cm 96	Codice	4CB48	4CB56	4CB64	4CB80	4CB96	Essenza 1	_____					Essenza 2	_____					Laccato opaco	_____				
	L. cm 48	L. cm 56	L. cm 64	L. cm 80	L. cm 96																										
Codice	4CB48	4CB56	4CB64	4CB80	4CB96																										
Essenza 1	_____																														
Essenza 2	_____																														
Laccato opaco	_____																														
	<table border="1"> <thead> <tr> <th></th> <th>L. cm 48</th> <th>L. cm 56</th> <th>L. cm 64</th> <th>L. cm 80</th> <th>L. cm 96</th> </tr> </thead> <tbody> <tr> <td>Codice</td> <td>1CA48</td> <td>1CA56</td> <td>1CA64</td> <td>1CA80</td> <td>1CA96</td> </tr> <tr> <td>Essenza 1</td> <td colspan="5">_____</td> </tr> <tr> <td>Essenza 2</td> <td colspan="5">_____</td> </tr> <tr> <td>Laccato opaco</td> <td colspan="5">_____</td> </tr> </tbody> </table>		L. cm 48	L. cm 56	L. cm 64	L. cm 80	L. cm 96	Codice	1CA48	1CA56	1CA64	1CA80	1CA96	Essenza 1	_____					Essenza 2	_____					Laccato opaco	_____				
	L. cm 48	L. cm 56	L. cm 64	L. cm 80	L. cm 96																										
Codice	1CA48	1CA56	1CA64	1CA80	1CA96																										
Essenza 1	_____																														
Essenza 2	_____																														
Laccato opaco	_____																														
	<table border="1"> <thead> <tr> <th></th> <th>L. cm 48</th> <th>L. cm 56</th> <th>L. cm 64</th> <th>L. cm 80</th> <th>L. cm 96</th> </tr> </thead> <tbody> <tr> <td>Codice</td> <td>2CAB48</td> <td>2CAB56</td> <td>2CAB64</td> <td>2CAB80</td> <td>2CAB96</td> </tr> <tr> <td>Essenza 1</td> <td colspan="5">_____</td> </tr> <tr> <td>Essenza 2</td> <td colspan="5">_____</td> </tr> <tr> <td>Laccato opaco</td> <td colspan="5">_____</td> </tr> </tbody> </table>		L. cm 48	L. cm 56	L. cm 64	L. cm 80	L. cm 96	Codice	2CAB48	2CAB56	2CAB64	2CAB80	2CAB96	Essenza 1	_____					Essenza 2	_____					Laccato opaco	_____				
	L. cm 48	L. cm 56	L. cm 64	L. cm 80	L. cm 96																										
Codice	2CAB48	2CAB56	2CAB64	2CAB80	2CAB96																										
Essenza 1	_____																														
Essenza 2	_____																														
Laccato opaco	_____																														
	<table border="1"> <thead> <tr> <th></th> <th>L. cm 48</th> <th>L. cm 56</th> <th>L. cm 64</th> <th>L. cm 80</th> <th>L. cm 96</th> </tr> </thead> <tbody> <tr> <td>Codice</td> <td>3CAB48</td> <td>3CAB56</td> <td>3CAB64</td> <td>3CAB80</td> <td>3CAB96</td> </tr> <tr> <td>Essenza 1</td> <td colspan="5">_____</td> </tr> <tr> <td>Essenza 2</td> <td colspan="5">_____</td> </tr> <tr> <td>Laccato opaco</td> <td colspan="5">_____</td> </tr> </tbody> </table>		L. cm 48	L. cm 56	L. cm 64	L. cm 80	L. cm 96	Codice	3CAB48	3CAB56	3CAB64	3CAB80	3CAB96	Essenza 1	_____					Essenza 2	_____					Laccato opaco	_____				
	L. cm 48	L. cm 56	L. cm 64	L. cm 80	L. cm 96																										
Codice	3CAB48	3CAB56	3CAB64	3CAB80	3CAB96																										
Essenza 1	_____																														
Essenza 2	_____																														
Laccato opaco	_____																														

MODULI CON CASSETTIERA ESTERNA E VANO A GIORNO P. cm 58,6

Moduli con cassetti, vano giorno e anta abbinabili ai moduli anta PIANA

Cassetti e anta con apertura premi/apri

Sommare al costo del modulo il costo dell'elemento a giorno nella finitura desiderata. Il prezzo è comprensivo di 1 fianco strutturale.

H. 261,6

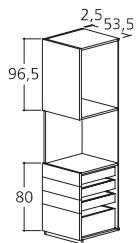

L. cm 53,5

Codice	C01B
Essenza 1	_____
Essenza 2	_____
Laccato opaco	_____

L. cm 53,5

Codice	EG1B
Essenza 1	_____
Essenza 2	_____
Laccato opaco	_____

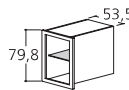

H. 295

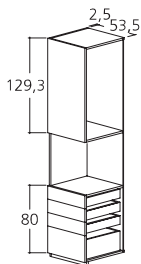

L. cm 53,5

Codice	C02B
Essenza 1	_____
Essenza 2	_____
Laccato opaco	_____

L. cm 53,5

Codice	EG1B
Essenza 1	_____
Essenza 2	_____
Laccato opaco	_____

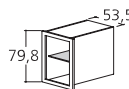

H. 261,6

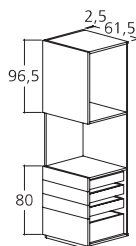

L. cm 61,5

Codice	C01
Essenza 1	_____
Essenza 2	_____
Laccato opaco	_____

L. cm 61,5

Codice	EG1
Essenza 1	_____
Essenza 2	_____
Laccato opaco	_____

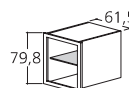

H. 295

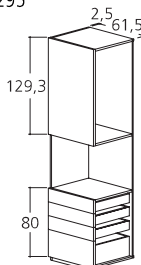

L. cm 61,5

Codice	C02
Essenza 1	_____
Essenza 2	_____
Laccato opaco	_____

L. cm 61,5

Codice	EG1
Essenza 1	_____
Essenza 2	_____
Laccato opaco	_____

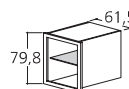

H. 261,6

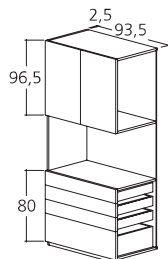

L. cm 93,5

Codice	C03
Essenza 1	_____
Essenza 2	_____
Laccato opaco	_____

L. cm 93,5

Codice	EG2
Essenza 1	_____
Essenza 2	_____
Laccato opaco	_____

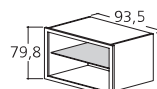

H. 295

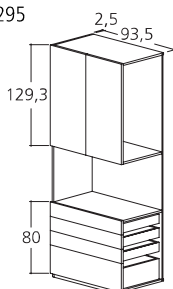

L. cm 93,5

Codice	C04
Essenza 1	_____
Essenza 2	_____
Laccato opaco	_____

L. cm 93,5

Codice	EG2
Essenza 1	_____
Essenza 2	_____
Laccato opaco	_____

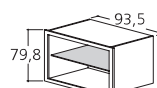

MODULI PER LAVATRICE - ASCIUGATRICE

CARATTERISTICHE:

I moduli per lavatrice - asciugatrice si abbinano ai moduli ad anta battente.

Sono posizionabili tra i fianchi di armadi a terra con ante mod. PIANA in spessore cm 2,5.

Sono privi di basamento e di schienale nella parte dove è alloggiato l'elettrodomestico.

I fianchi laterali speciali P. cm 63,6 permettono di aumentare la profondità utile per l'incasso degli elettrodomestici e di lasciare un vuoto tecnico tra schiena e muro per eventuale passaggio di cavi e tubazioni.

N.B.: prezzo escluso fianchi.

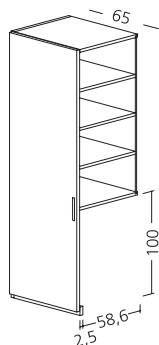
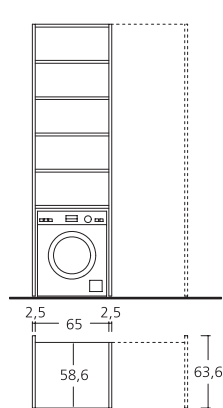

Altezze	Codice	Essenza 1	Essenza 2	Laccato Opaco	Codice	Fianco speciale P. cm 63,6 Melaminico
H. cm 230,8	MLA23A				SL31	
H. cm 246,8	MLA24A				SL46	
H. cm 261,6	MLA26A				SL62	
H. cm 294,8	MLA29A				SL95	
Supplemento finitura fianco esterno (cad.)	FFL31					

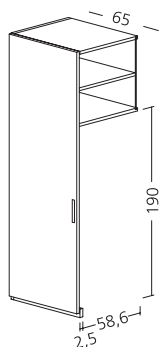
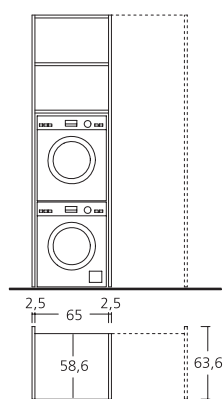

Altezze	Codice	Essenza 1	Essenza 2	Laccato Opaco	Codice	Fianco speciale P. cm 63,6 Melaminico
H. cm 230,8	MLA23B				SL31	
H. cm 246,8	MLA24B				SL46	
H. cm 261,6	MLA26B				SL62	
H. cm 294,8	MLA29B				SL95	
Supplemento finitura fianco esterno (cad.)	FFL31					

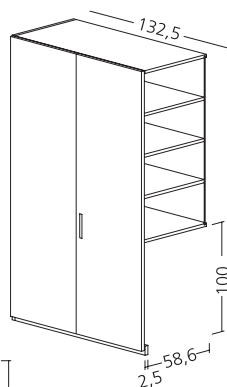
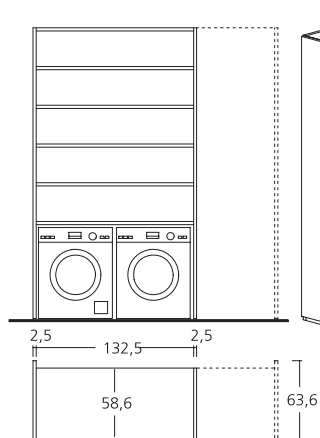

Altezze	Codice	Essenza 1	Essenza 2	Laccato Opaco	Codice	Fianco speciale P. cm 63,6 Melaminico
H. cm 230,8	MLA23C				SL31	
H. cm 246,8	MLA24C				SL46	
H. cm 261,6	MLA26C				SL62	
H. cm 294,8	MLA29C				SL95	
Supplemento finitura fianco esterno (cad.)	FFL31					



MODULI A GIORNO ATTREZZABILI H. 261,6 - Con schienale portante fresato per posizionamento attrezzature

CARATTERISTICHE:

I moduli a giorno attrezzabili possono essere abbinati ad armadi con anta battente ed armadi con anta scorrevole.

Sono realizzati in tutte le essenze e laccature del programma.



I moduli hanno fianchi indipendenti e vanno inseriti tra i moduli armadio finiti con fianco terminale in melaminico.

Lo schienale è fresato come da schema e tali fresature fungono da innesto per ganci posizionati sulla parte posteriore delle attrezzature.

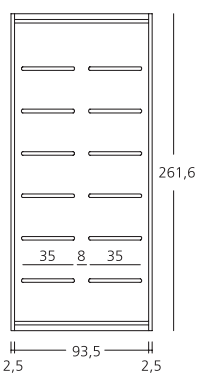
I moduli sono predisposti per l'inserimento del porta TV GHOST estraibile.



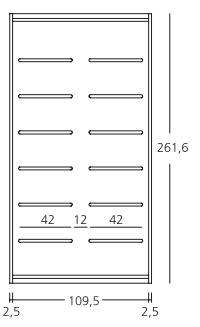

Descrizione	Modulo H. 261,6	Cassettiera P. 44,2	Ripiano	Ripiano	Porta TV GHOST
Dimensioni	L. cm 98,5	L. cm 78 H. 48	L. cm 35	L. cm 78	L. cm 93,5
Codice	MGA01	MGAC2	OTR35	OTR78	GH1RF
Essenza 1					
Essenza 2					
Laccato opaco					

		
	L. cm 35	L. cm 78
Codice	OTT35	OTT78
Tubo appendiabiti		



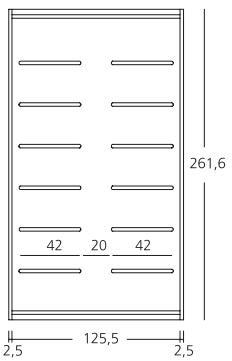

Descrizione	Modulo H. 261,6	Cassettiera P. 44,2	Cassettiera P. 44,2	Ripiano	Ripiano	Porta TV GHOST
Dimensioni	L. cm 114,5	L. cm 42 H. 48	L. cm 96 H. 48	L. cm 42	L. cm 96	L. cm 93,5
Codice	MGA02	MGAC1	MGAC3	OTR42	OTR96	GH1RF
Essenza 1						
Essenza 2						
Laccato opaco						

		
	L. cm 42	L. cm 96
Codice	OTT42	OTT96
Tubo appendiabiti		



Descrizione	Modulo H. 261,6	Cassettiera P. 44,2	Cassettiera P. 44,2	Ripiano	Ripiano	Porta TV GHOST
Dimensioni	L. cm 130,5	L. cm 42 H. 48	L. cm 104 H. 48	L. cm 42	L. cm 104	L. cm 125,5
Codice	MGA03	MGAC1	MGAC4	OTR42	OTR104	GH1LRF
Essenza 1						
Essenza 2						
Laccato opaco						

		
	L. cm 42	L. cm 104
Codice	OTT42	OTT104
Tubo appendiabiti		

ANGOLO SPOGLIATOIO

**ATTENZIONE!
DOPPIO FIANCO**

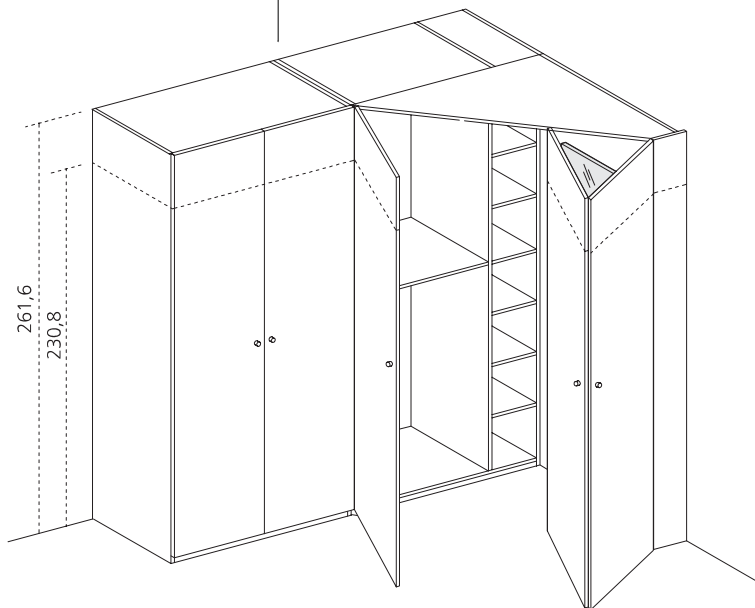

Con 1 coppia di ante pieghevoli
cm 47,5 + 47,5

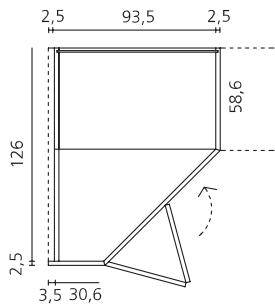

Con 1 anta battente da cm 47,5 e 1 coppia
di ante pieghevoli da cm 47,5 + 47,5

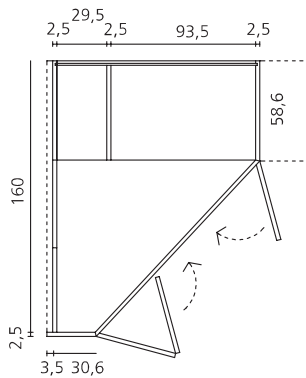

Con 1 coppia di ante pieghevoli
cm 47,5 + 47,5

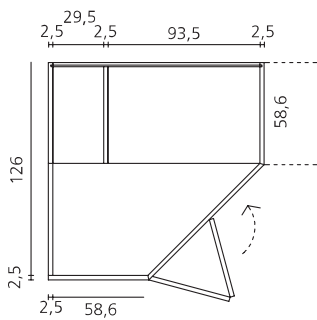

Con 1 anta battente da cm 47,5 e 1 coppia
di ante pieghevoli da cm 47,5 + 47,5

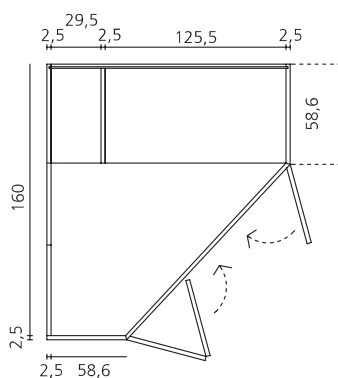

ANGOLO SPOGLIATOIO H. cm 230,8

- Compreso fianchi struttura
- Compreso 1 ripiano interno
- Compreso lampada LED con sensore
- Escluse maniglie

L. cm. 102 x 128,5

Con 1 coppia di ante pieghevoli
Con 2 faretti

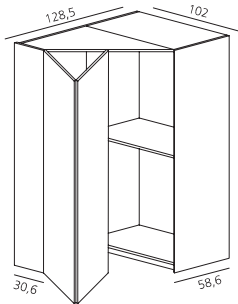

L. cm. 130,5 x 128,5

Con 1 coppia di ante pieghevoli
Con 2 faretti

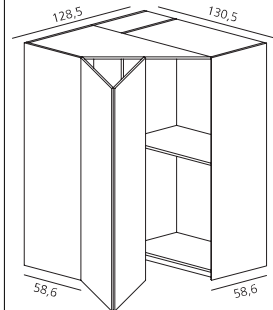

ANTA PIANA	Codice	ASS1	ASS1B
	Essenza 1	_____	_____
	Essenza 2	_____	_____
	Laccato opaco	_____	_____
ANTA TRATTINO	Codice	ASS3	ASS3B
	Essenza 1	_____	_____
	Essenza 2	_____	_____
	Laccato opaco	_____	_____
ANTA SEGNO	Codice	ASS8	ASS8B
	Essenza 1	_____	_____
	Essenza 2	_____	_____
	Laccato opaco	_____	_____
ANTA GROOVE	Codice	ASS9	ASS9B
	Essenza 1	_____	_____
	Essenza 2	_____	_____
	Laccato opaco	_____	_____

L. cm. 134 x 162,5

Con coppie ante pieghevoli + 1 battente
Con 2 faretti

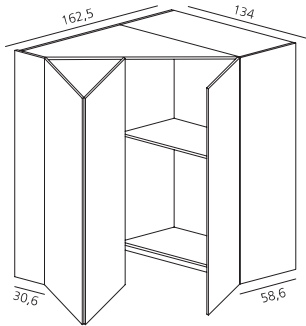

L. cm. 162,5 x 162,5

Con coppie ante pieghevoli + 1 battente
Con 2 faretti

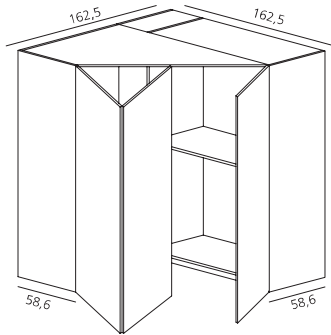

ASS1C	ASS1D	FF31	
			aggiungere supplemento per finitura fianchi esterni
ASS3C	ASS3D	FF31	
			aggiungere supplemento per finitura fianchi esterni
ASS8C	ASS8D	FF31	
			aggiungere supplemento per finitura fianchi esterni
ASS9C	ASS9D	FF31	
			aggiungere supplemento per finitura fianchi esterni

ANGOLO SPOGLIATOIO H. cm 261,6

- Compreso fianchi struttura
- Compreso 1 ripiano interno
- Compreso lampada LED con sensore
- Escluse maniglie

L. cm. 102 x 128,5

Con 1 coppia di ante pieghevoli
Con 2 faretti

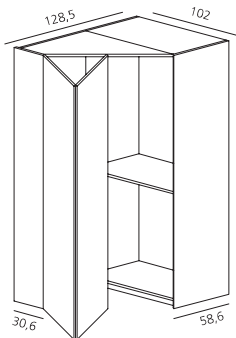

L. cm. 130,5 x 128,5

Con 1 coppia di ante pieghevoli
Con 2 faretti

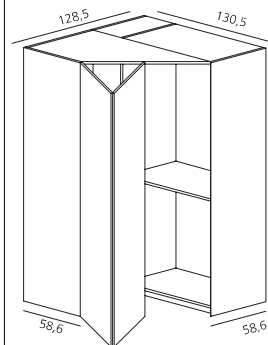

ANTA PIANA	Codice	ASS1E	ASS1F
	Essenza 1	_____	_____
	Essenza 2	_____	_____
	Laccato opaco	_____	_____
ANTA TRATTINO	Codice	ASS3E	ASS3F
	Essenza 1	_____	_____
	Essenza 2	_____	_____
	Laccato opaco	_____	_____
ANTA SEGNO	Codice	ASS8E	ASS8F
	Essenza 1	_____	_____
	Essenza 2	_____	_____
	Laccato opaco	_____	_____
ANTA GROOVE	Codice	ASS9E	ASS9F
	Essenza 1	_____	_____
	Essenza 2	_____	_____
	Laccato opaco	_____	_____

L. cm. 134 x 162,5

Con coppie ante pieghevoli + 1 battente
Con 2 faretti

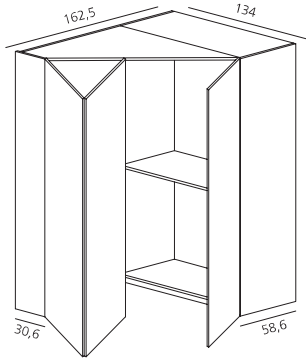

L. cm. 162,5 x 162,5

Con coppie ante pieghevoli + 1 battente
Con 2 faretti

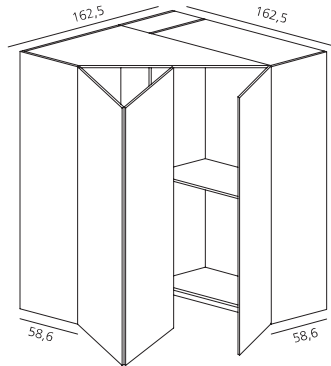

ASS1G	ASS1H	FF31	
_____	_____	_____	aggiungere supplemento
_____	_____	_____	per finitura fianchi esterni
_____	_____	_____	
ASS3G	ASS3H	FF31	
_____	_____	_____	aggiungere supplemento
_____	_____	_____	per finitura fianchi esterni
_____	_____	_____	
ASS8G	ASS8H	FF31	
_____	_____	_____	aggiungere supplemento
_____	_____	_____	per finitura fianchi esterni
_____	_____	_____	
ASS9G	ASS9H	FF31	
_____	_____	_____	aggiungere supplemento
_____	_____	_____	per finitura fianchi esterni
_____	_____	_____	

ATTREZZATURE PER SPOGLIATOIO

SPECCHIO INTERNO

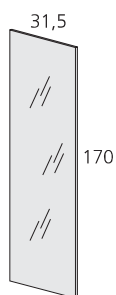

Codice 170 x 31,5
S01

CASSETTIERA SU RUOTE

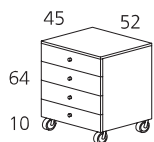

Codice 52 X 45 X H 64
CA01
Laccato

APPENDIABITI



Codice AP
