

# DO RO TEA

CLAUDIO LOVADINA

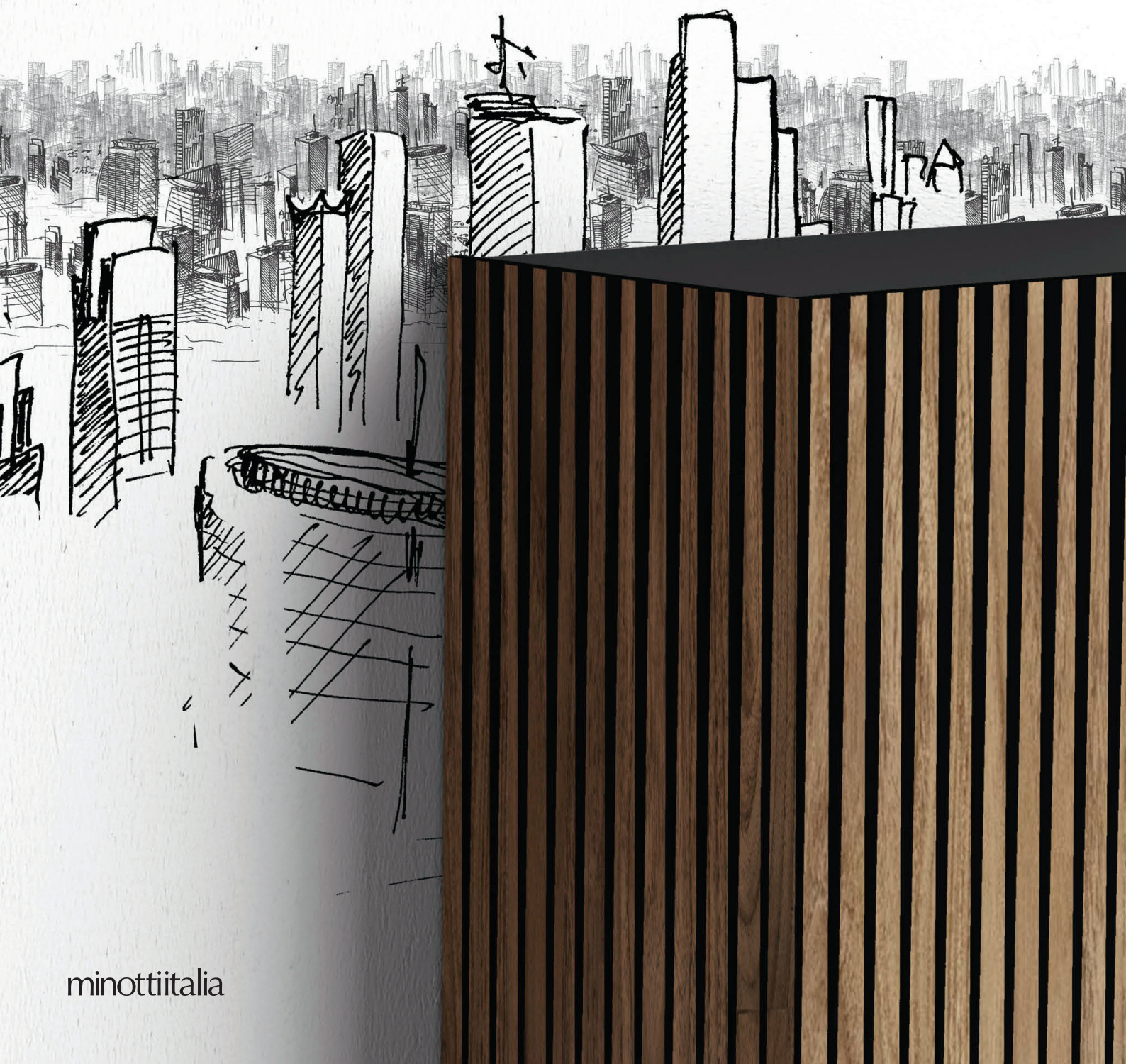

Contenitori (credenza / madia) con ante battenti e spalle in agglomerato di legno in pasta nera, lavorate a sezioni triangolari con effetto tridimensionale, superfici esterne in legno di teak, finitura trasparente opaca. Disponibile con zoccolo nero altezza 3 cm o piedini altezza 10 cm in metallo satinato colore ottone o nichel. Struttura interna finitura gofrata colore noir.

Storage units (sideboard / high sideboard) with hinged doors and sides in composite wood in black paste, worked at triangular sections with tridimensional effect, external surfaces in teak wood, transparent matt finish, available with 3 cm black wooden base or 10 cm. h. feet in satin metal brass or nickel colour. Internal structure in embossed finish colour noir.



**DOROTEA**  
**CREDENZA / SIDEBOARD**

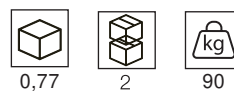
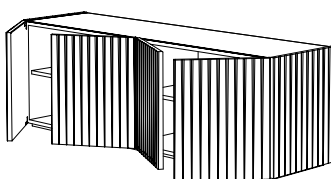
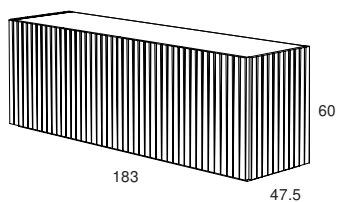

**DOROTEA**  
**MADIA / HIDE CONTAINER**

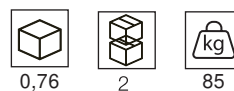
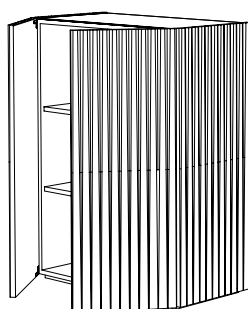
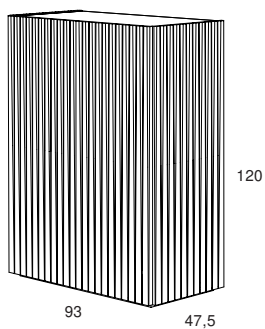

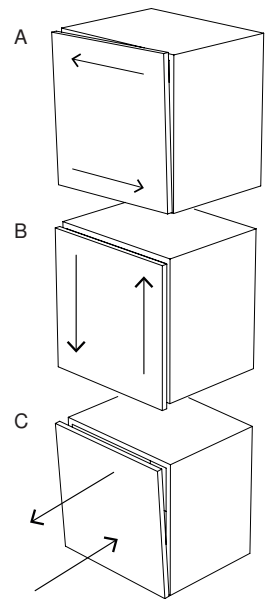
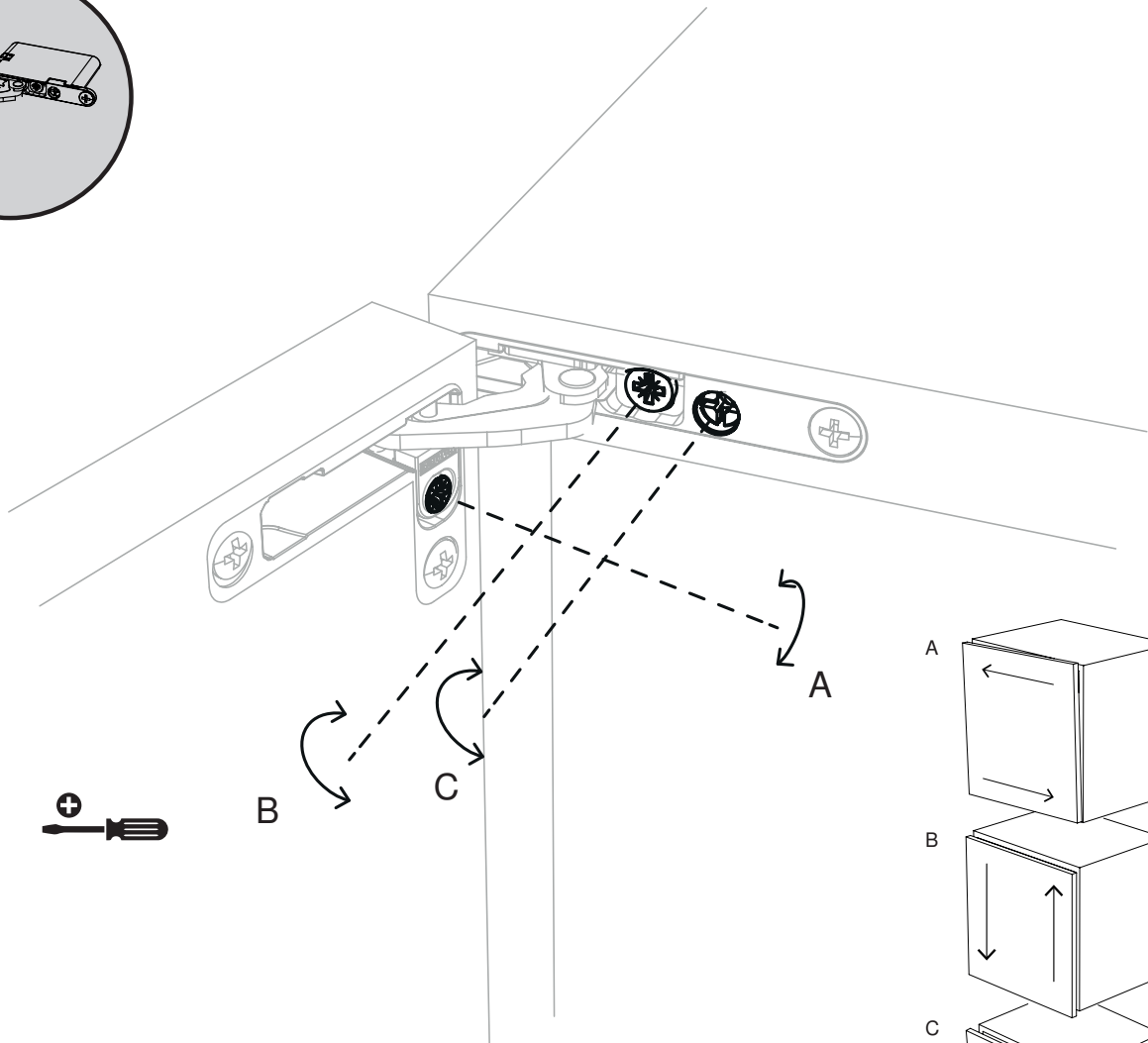
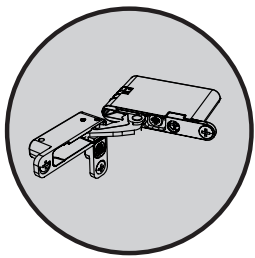
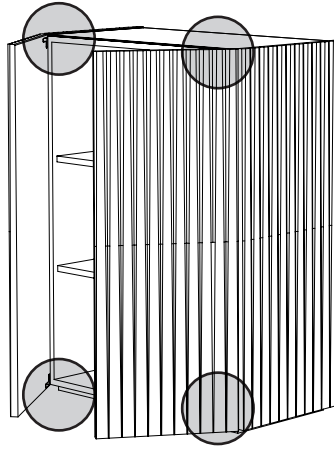
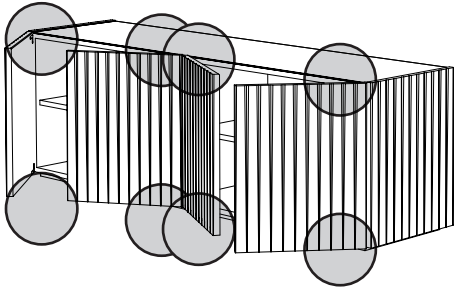

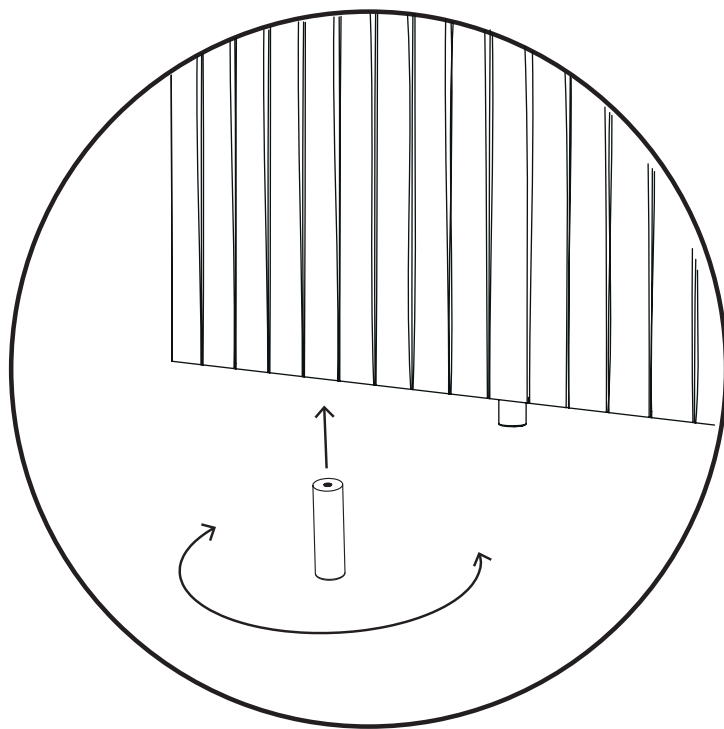
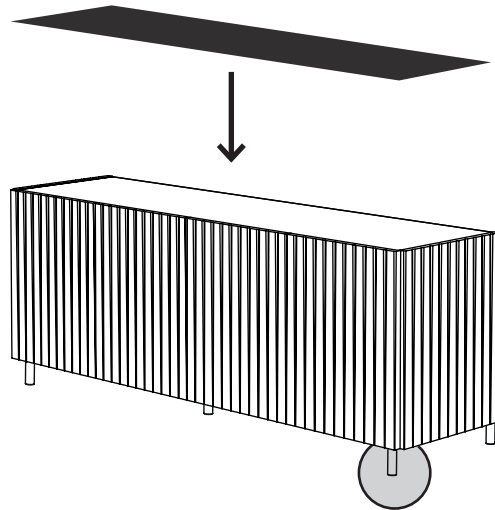
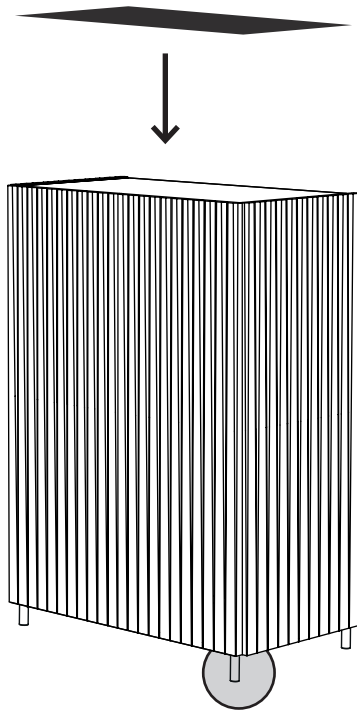

































minottiitalia

# DA TI TE CNI CI TE CH NIC AL DA TA

	LACCATURA GOFFRATA NEI COLORI A CAMPIONARIO		TEAK OPACO / MDF NERO
	FOGLIA ORO		CEMENTO BIANCO
	FOGLIA ARGENTO		CEMENTO GRIGIO
	OTTONE LUCIDO		LED LUCE BIANCA CALDA / FREDDA (3000/6000 K)
	NICHEL LUCIDO		LED LUCE CALDA 4 CANALI ( RGB WW )
	OTTONE SATINATO		MODULO DESTRO / SINISTRO
	NICHEL SATINATO		FISSAGGIO A PARETE
	INOX		ASSEMBLARE
	METALLO BIANCO GOFFRATO		RIPIANO SPOSTABILE
	METALLO ANTRACITE GOFFRATO		RIPIANO FISSO
	METALLO BIANCO OPACO		VOLUME
	NICHEL NERO		NUMERO DI COLLI
	SPECCHIO STANDARD		PESO
	SPECCHIO BRONZATO		
	SPECCHIO FUME'		
	APERTURA VASISTAS / RIBALTA		
	APERTURA DESTRA / SINISTRA		
	RIPIANO IN CRISTALLO EXTRA CHIARO		
	ESSENZA LARICE SPAZZOLATO / FINITURA LACCATO GOFFRATO NEI COLORI A CAMPIONARIO		

A.  
D.  
&  
GRA  
PH  
ICS

STUDIO14

minottiitalia

ADION S.R.L.  
VIALE REPUBBLICA, 140  
22060 – CABIATE – COMO  
+39 031 769 251  
INFO@MINOTTIITALIA.IT  
WWW.MINOTTIITALIA.IT